

Three phase inverters 3 to 6 kW

# ASW LT-G2 Pro Series

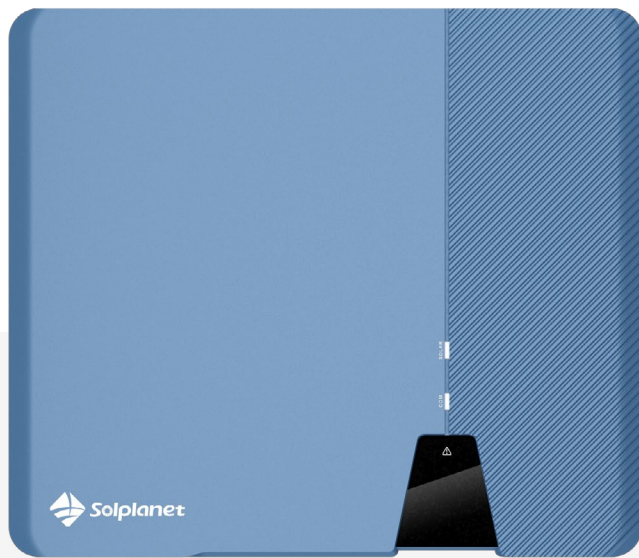

Models:

ASW3K-LT-G2 Pro

ASW4K-LT-G2 Pro

ASW5K-LT-G2 Pro

ASW6K-LT-G2 Pro



## Easy-to-install

- Toolless DC connection via Phoenix Contact connectors
- Quick setup and commissioning with AiSWEI apps
- Compact wall mount design



## Reliable

- International quality standards
- 150 % PV array oversizing for higher yields
- IP66 rated design for outdoor use



## User-friendly

- User friendly app interface
- 16 A input current, ideal for bifacial and large area PV modules
- Wide MPP voltage range 150V-1000V

# Technical Datasheet

ASW 3K-LT-G2 Pro ASW 4K-LT-G2 Pro ASW 5K-LT-G2 Pro

ASW 6K-LT-G2 Pro

Input (DC)	Max. PV array power	4500 Wp STC	6000 Wp STC	7500 Wp STC	9000 Wp STC
	Max. input voltage	1100 V			
	MPP voltage range / rated input voltage	150 V to 1000 V / 630 V			
	Min. input voltage	125 V			
	Initial. feed-in voltage	180 V			
	Max. operating input current	16 A / 16 A			
	Max. short circuit current	25 A / 25 A			
	No. of independent MPPT inputs / strings per MPPT input	2 / A : 1 ; B : 1			
Output (AC)	Rated power	3000 W	4000 W	5000 W	6000 W
	Max. apparent AC power	3000 VA <sup>384</sup>	3680 VA <sup>384</sup>	4000 VA <sup>384</sup>	5000 VA <sup>384</sup>
	AC nominal voltage	220 V / 380 V 230 V / 400 V 240 V / 415 V			
	AC voltage range	160 V to 300 V			
	AC grid frequency / range	50 Hz / 45 Hz to 55 Hz 60 Hz / 55 Hz to 65 Hz			
	Max. output current	4.8 A	6.4 A	8.0 A	9.6 A
	Adjustable power factor range	0.8 leading to 0.8 lagging			
	Feed-in phases	3 / 3-N-PE			
	Harmonic distortion (THD) at rated output	< 3 %			
	Efficiency & Protection	Max. efficiency / European efficiency	98.3 % / 97.9 %		
DC Switch					
Ground fault monitoring / grid monitoring		/			
DC reverse polarity protection / AC short circuit protection		/			
All-pole-sensitive residual-current monitoring unit					
Protection class (according to IEC 62109-1) / overvoltage category (according to IEC 62109-1)		I / AC : III ; DC : II			
General data	Dimensions (W / H / D)	503 / 435 / 183 mm			
	Weight	< 15 kg			
	Operating temperature range	-25°C ... +60°C			
	Self-consumption (at night)	< 1 W			
	Topology	Transformerless			
	Cooling concept	Natural Convection			
	Degree of protection (according to IEC 60529)	IP66			
	Climatic category (according to IEC 60721-3-4)	4K4H			
	Max. permissible value for relative humidity (non-condensing)	1			
Max. operating altitude	3000 m				
Features	DC connection	Phoenix Contact			
	AC connection	Plug-in connector			
	Mounting type	Wall-mount bracket			
	LED indicators (Status / Fault / Communication)				
	Communication interface <sup>182</sup>	Wi-Fi / 4G / RS485 (Optional)			
	Certificates and approvals (more available on request)	CE, EN50549, G98/99, VDE-AR-N4105, AS/NZS 4777, C10/C11, VFR 2014 & UTE C15, IEC62109, IEC62116, IEC61727, IEC61683, IEC60068, IEC61000, NB/T 32004			

Standard features / optional features / – not available

1- Zero export installations supported with 2-pin RS485 for connection to approved smart meters

2- DRED supported with RS485 communication for Australia & New Zealand

3- The overload setting is disabled as default for AS/NZS4777 grid codes

4- For European and AS/NZS4777 grid codes the max. apparent AC power is equal to the rated power

Version: March 2022



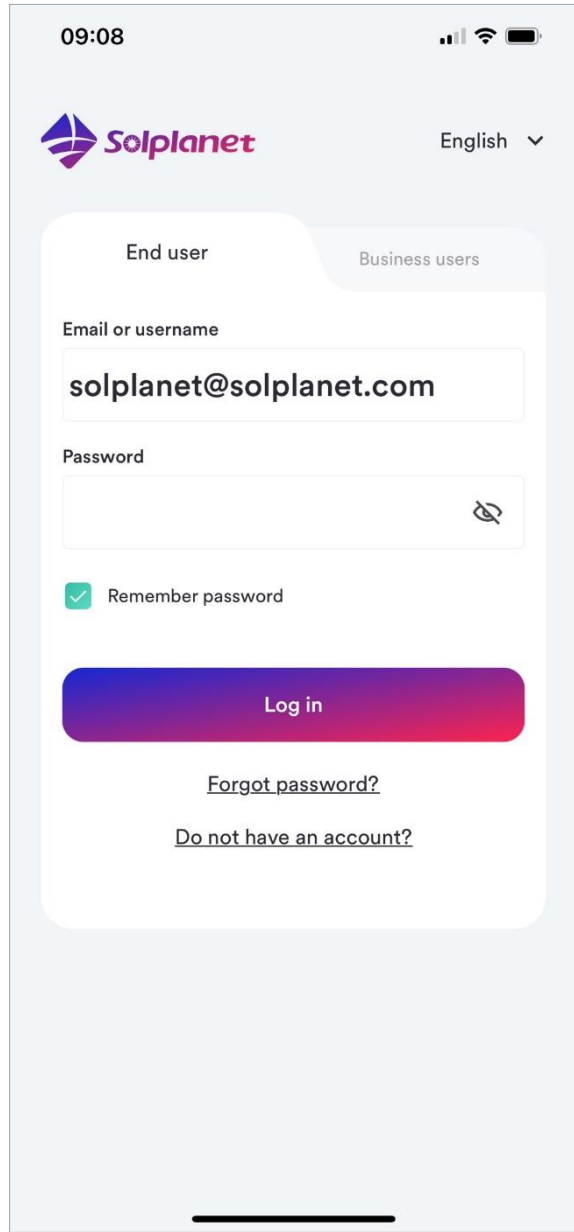

1. About this Document

This document describes the activities related to the creation of a PV plant, set-up and commissioning of a Solplanet inverter and connecting the Solplanet inverter to a WiFi network.

The contents of this quick guide apply to the following models:

- ASWx000S-S
- ASWx000-S
- ASWx000-T
- ASWxxK-LT
- ASWxxK-LT-G2
- ASW TLCx000

The firmware of the Solplanet WiFi stick should be 19B01-0021R or greater. Please contact the Solplanet service team in your region if in doubt.

2. Items Required

- Solplanet inverter with a WiFi stick
- WiFi stick with firmware greater than 19B01-0021R
- iOS or Android based mobile device
- Solplanet app

3. Before Using the App

Please ensure the following has been completed before using this quick guide:

- A Solplanet inverter installed as per the Solplanet guidelines
- A Solplanet WiFi stick has been connected to the inverter
- The inverter has been connected to a string of solar panels of the appropriate voltage or to a DC power source
- The inverter DC switch is in the "ON" position
- Ensure the WiFi stick's green LED is solid ON and the blue LED is OFF

If the blue LED is solid ON before your first attempt to begin, the WiFi stick may have already connected to a WiFi network. Please contact the Solplanet service team in your region if this is the case.

4. WiFi Stick LED Indicators

There are two LED indicators on the WiFi stick, the state of each LED indicator is defined in the table below:

	Solid OFF	Solid ON	Blinking
<b>Green LED</b>	<ul style="list-style-type: none"> <li>• WiFi stick is OFF</li> </ul>	<ul style="list-style-type: none"> <li>• WiFi stick is ON</li> </ul>	<ul style="list-style-type: none"> <li>• NA</li> </ul>
<b>Blue LED</b>	<ul style="list-style-type: none"> <li>• Not connected to WiFi</li> <li>• ASW-XXXX access point is ON</li> </ul>	<ul style="list-style-type: none"> <li>• Connected to WiFi</li> <li>• ASW-XXXX access point is OFF</li> </ul>	<ul style="list-style-type: none"> <li>• Connected to WiFi</li> <li>• ASW-XXXX access point is OFF</li> <li>• Data cannot be sent to server</li> </ul>

5. App Download

To download the Solplanet app, please scan the appropriate QR code below.



Android



iOS

6. Account Registration

An account can be created in the following ways:

- Tapping on "Do not have an account?" on the login screen of the app, selecting the appropriate user type and following the prompts
- Registration is possible using either an email or a registered cellular phone number

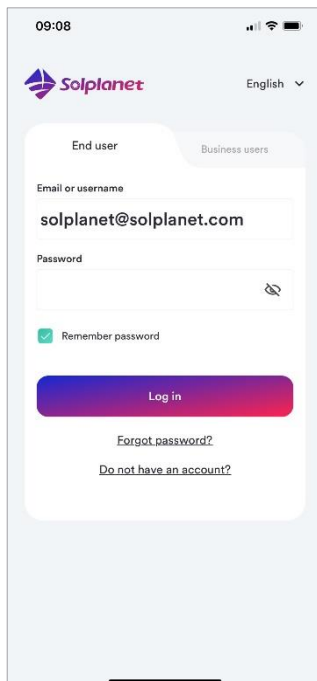

- Log into the App after the account has been registered.

7. Create PV Plant

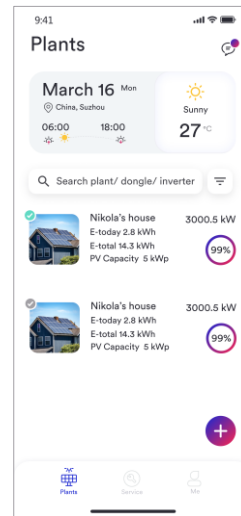

1. Tap "+"



2. Tap "Create or modify a plant"



3. Scan WiFi stick QR code or manually enter the serial number and the registration code

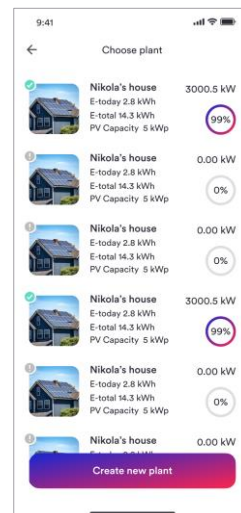

4. Tap "Create new plant"

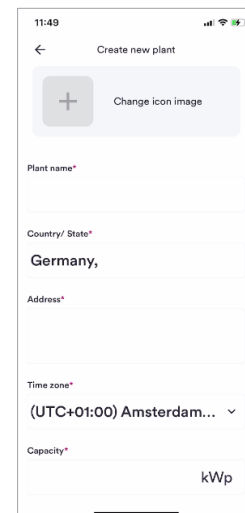

5. Enter PV plant information in all fields marked with a red asterisk and tap "Create"  
6. Optional: turn on the App location services

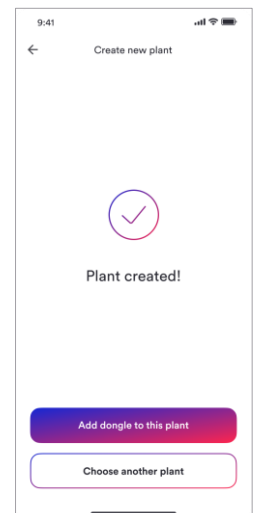

7. Tap "Add dongle to this plant"

## 8. Inverter Set-up

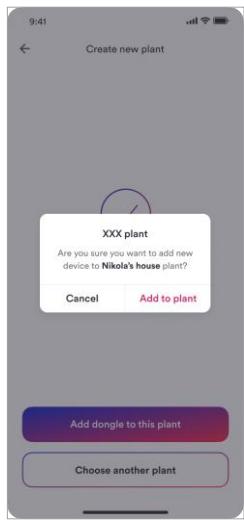

8. Tap "Add to plant"

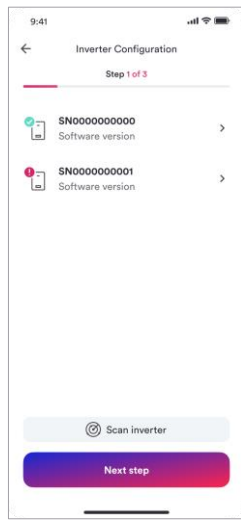

9. Tap the inverter serial number that matches your inverter – TIP: tape "Scan inverter" if the inverter is displayed as "Unknown"

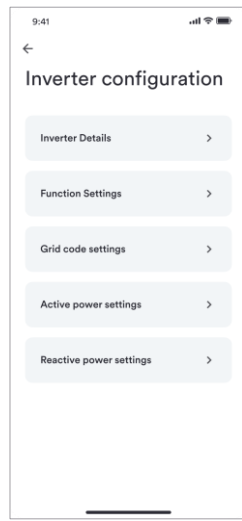

10. Tap "Grid" code settings"

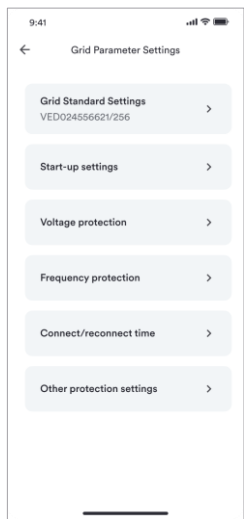

11. Tap "Grid code settings"

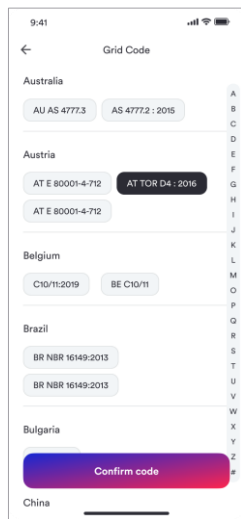

12. Select the correct grid code and tap "Save"  
13. Tap return arrow three times to return to inverter list

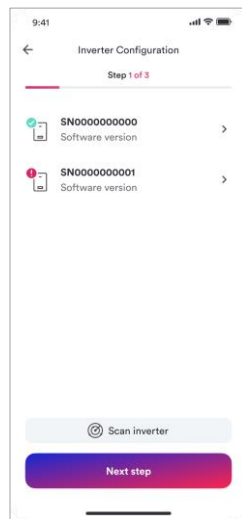

14. Tap "Next step"

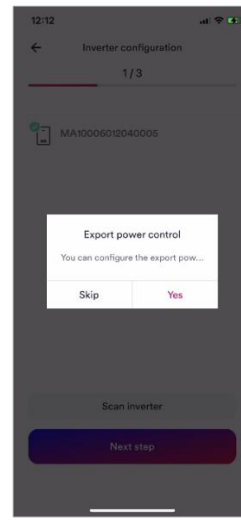

15. To set up export power limitation or consumption monitoring tap "Yes" otherwise tap "Skip" and proceed to step 21

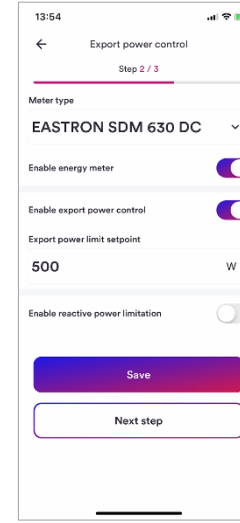

16. Select meter type  
17. Enable energy meter  
18. Enable export power control  
19. Enter "Export Power Limit Setpoint" in watts (W)  
20. Tap "Save"  
21. Tap "Next step"

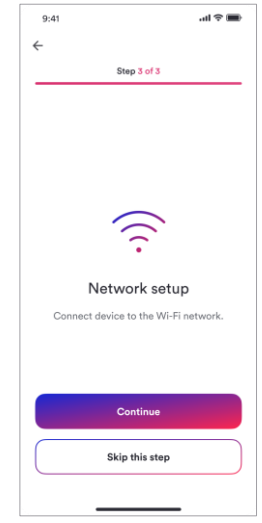

22. Tap "Continue"

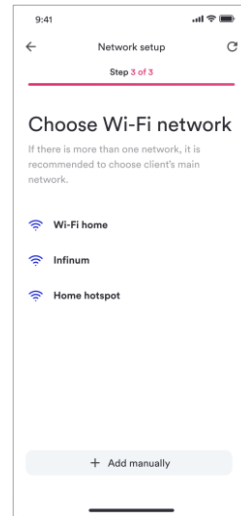

23. Select WiFi network from list

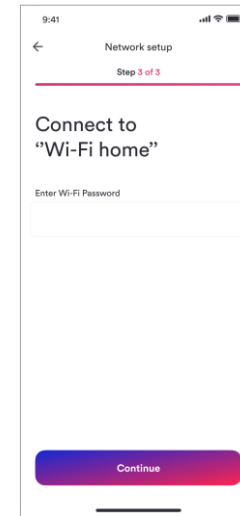

24. Enter WiFi password and tape "continue"

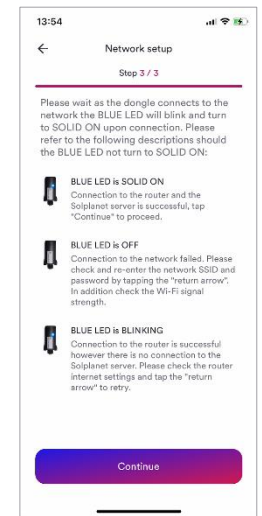

25. Follow the prompts on the page to confirm whether the dongle is configured with a network. If the BLUE LED is SOLID ON, click "Continue". Otherwise, go back to the previous step.

4

5

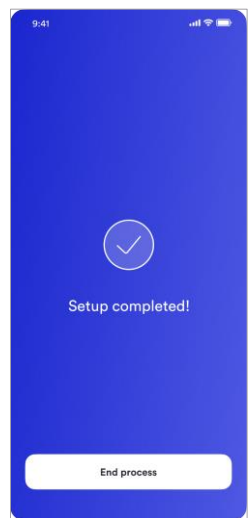

26. Setup is now completed, tap "End process" and the PV plant will now be shown on the PV plant list.

## 9. Contact

If you have any technical problems with our products, please contact our service. Provide the following information to assist in providing you with the necessary assistance:

- Inverter device type
- Inverter serial number
- Type and number of connected PV modules
- Error code
- Mounting location
- Warranty card
- Mobile device type

**SOLPLANET INTERNATIONAL**  
service@solplanet.net

**SOLPLANET AUSTRALIA**  
Service: +61 390 988 674  
service.au@solplanet.net

**SOLPLANET BRAZIL**  
Support: +55 51 99765 3389

**SOLPLANET GERMANY**  
Service: +31 20 800 4844  
service.eu@solplanet.net

**SOLPLANET HUNGARY**  
Service: +36 465 00 384  
service.hu@solplanet.net

**SOLPLANET KOREA**  
Service: +82 31 422 8110  
Service.kr@solplanet.com

**SOLPLANET POLAND**  
Service: +48 13 4926 109  
service.pl@solplanet.net

**SOLPLANET SOUTH AFRICA**  
service@solplanet.com

**SOLPLANET SPAIN**  
Service: +31 20 800 4844 (EN)  
service.eu@solplanet.net

**SOLPLANET SWEDEN**  
Service: +31 20 800 4844 (EN)  
service.eu@solplanet.net

**SOLPLANET THE NETHERLANDS**  
Service: +31 20 800 4844 (EN)  
service.eu@solplanet.net

**SOLPLANET TURKEY**  
Service: +90 850 346 00 24  
service.tr@solplanet.net

**AISWEI GREATER CHINA**  
Service: +86 400 801 9996  
[service.china@aiswei-tech.com](mailto:service.china@aiswei-tech.com)

6

7

# Three phase string inverters



**plenti**SOLAR  
Erneuerbare Energie

## ASW LT SERIES

### User Manual

ASW3K / 4K / 5K / 6K / 8K / 10K / 12K / 15K /  
17K / 20K-LT-G2-Pro

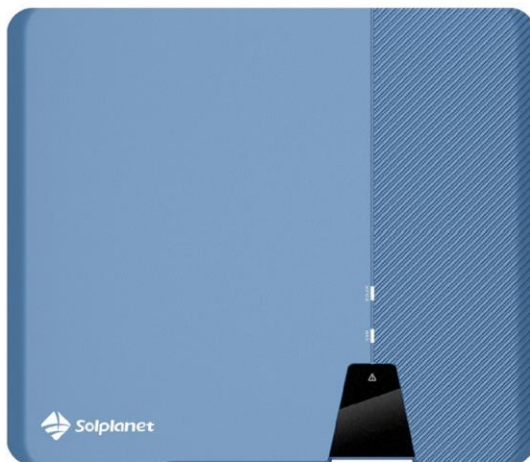

# ASW LT-G2-Pro series inverter Table of Contents

---

<b>1 Notes on this Manual</b> .....	<b>4</b>
<b>1.1 General Notes</b> .....	<b>4</b>
<b>1.2 Area of Validity</b> .....	<b>4</b>
<b>1.3 Target group</b> .....	<b>5</b>
<b>1.4 Symbols used in this manual</b> .....	<b>5</b>
<b>2 Safety</b> .....	<b>7</b>
<b>2.1 Intended use</b> .....	<b>7</b>
<b>2.2 Important safety information</b> .....	<b>8</b>
<b>2.3 Symbols on the label</b> .....	<b>9</b>
<b>3 Unpacking</b> .....	<b>11</b>
<b>3.1 Scope of delivery</b> .....	<b>11</b>
<b>3.2 Check for transport damage</b> .....	<b>12</b>
<b>4 Mounting</b> .....	<b>13</b>
<b>4.1 Requirements for mounting</b> .....	<b>13</b>
<b>4.2 Mounting the inverter</b> .....	<b>17</b>
<b>5 Electrical connection</b> .....	<b>20</b>
<b>5.1 Safety</b> .....	<b>20</b>
<b>5.2 Electrical Connection Panel</b> .....	<b>21</b>
<b>5.3 Electrical connection diagram with a separate DC isolator</b> .....	<b>22</b>
<b>5.4 AC Connection</b> .....	<b>22</b>
<b>5.4.1 Conditions for the AC connection</b> .....	<b>22</b>

5.4.2 Grid connection.....	25
5.4.3 Additional grounding connection.....	27
5.5 DC connection .....	28
5.5.1 Requirements for the DC connetion.....	28
5.5.2 Assembling the DC connectors.....	29
5.5.3 Disassembling the DC connectors.....	30
5.5.4 Connecting the PV Array.....	32
5.6 Communication equipment connection.....	34
5.6.1 Mounting the WiFi or 4G Stick.....	34
5.6.2 Connect the RS485 network cable .....	35
5.6.3 Connect the smart meter cable.....	37
<b>6 Communication .....</b>	<b>38</b>
6.1 System monitoring via WLAN .....	38
6.2 Active power control with Smart meter.....	39
6.3 Remote firmware update.....	40
6.4 Active power control via demand response enabling device (DRED) .....	40
6.5 Communication with the third party device.....	41
6.6 Earth fault alarm .....	41
<b>7 Commissioning.....</b>	<b>42</b>
7.1 Electrical check .....	42
7.2 Mechanical check.....	43
7.3 Safety code check .....	44
7.4 Start-up.....	44

<b>8 Display .....</b>	<b>46</b>
<b>8.1 Overview of the control panel .....</b>	<b>46</b>
<b>8.2 LED indicators .....</b>	<b>46</b>
<b>9 Disconnecting the inverter from voltage sources .....</b>	<b>48</b>
<b>10 Technical data.....</b>	<b>50</b>
<b>10.1 DC input data .....</b>	<b>50</b>
<b>10.2 AC output data .....</b>	<b>53</b>
<b>10.3 General data .....</b>	<b>57</b>
<b>10.4 Safety regulations .....</b>	<b>57</b>
<b>10.5 Tools and torque .....</b>	<b>59</b>
<b>11 Troubleshooting .....</b>	<b>61</b>
<b>12 Maintenance.....</b>	<b>64</b>
<b>12.1 Cleaning the contacts of the DC-switch.....</b>	<b>64</b>
<b>12.2 Cleaning the heat sink .....</b>	<b>64</b>
<b>13 Recycling and disposal .....</b>	<b>65</b>
<b>14 EU Declaration of Conformity .....</b>	<b>65</b>
<b>15 Warranty.....</b>	<b>66</b>
<b>16 Contact.....</b>	<b>66</b>



# 1 Notes on this Manual

---

## 1.1 General Notes

---

ASW LT-G2-Pro series inverter is a three-phase transformerless string inverter with two independent MPPTs. It converts the direct current (DC) generated by the photovoltaic (PV) module into a three-phase alternating current (AC) and feeds it into the utility grid.

## 1.2 Area of Validity

---

This manual describes the mounting, installation, commissioning and maintenance of the following inverters:

ASW3K-LT-G2-Pro

ASW4K-LT-G2-Pro

ASW5K-LT-G2-Pro

ASW6K-LT-G2-Pro

ASW8K-LT-G2-Pro

ASW10K-LT-G2-Pro

ASW12K-LT-G2-Pro

ASW13K-LT-G2-Pro

ASW15K-LT-G2-Pro

ASW17K-LT-G2-Pro

ASW20K-LT-G2-Pro

Please read this manual carefully before using this product, keep it in a convenient place and make it available at all times.

## 1.3 Target group

---

This document is for qualified electricians only, who must perform the tasks exactly as described.

All persons installing inverters must be trained and experienced in general safety which must be observed when working on electrical equipment.

Installation personnel should also be familiar with local requirements, rules and regulations.

Qualified persons must have the following skills:

- Knowledge of how an inverter works and is operated
- Training in how to deal with the dangers and risks associated with installing, repairing and using electrical devices and installations
- Training in the installation and commissioning of electrical devices and installations
- Knowledge of the applicable laws, standards and directives
- Knowledge of and compliance with this document and all safety information.

## 1.4 Symbols used in this manual

---

Safety instructions will be highlighted with the following symbols:



DANGER indicates a hazardous situation which, if not be avoided, will result in death or serious injury.



WARNING indicates a hazardous situation which, if not be avoided, can result in death or serious injury.

 **CAUTION**

CAUTION indicates a hazardous situation which, if not be avoided, can result in minor or moderate injury.

**NOTICE**

NOTICE indicates a situation which, if not be avoided, can result in property damage.



INFORMATION that is important for a specific topic or goal, but is not safety-relevant.

## 2 Safety

---

### 2.1 Intended use

---

1. ASW LT-G2-Pro series inverter converts the direct current from the PV arrays into grid-compliant alternating current.
2. ASW LT-G2-Pro series inverter is suitable for indoor and outdoor use.
3. ASW LT-G2-Pro series inverter must only be operated with PV arrays (PV modules and cabling) of protection class II in accordance with IEC 61730, application class A. Do not connect any sources of energy other than PV modules to ASW LT-G2-Pro series inverter.
4. PV modules with a high capacity to ground must only be used if their coupling capacity does not exceed  $5.0\mu\text{F}$ .
5. When the PV modules are exposed to light, a DC voltage is supplied to this inverter.
6. When designing the PV power plants, ensure that the values comply with the permitted operating range of all components at all time.
7. The product must only be used in countries for which it is approved or released by AISWEI and the grid operator.
8. Use this product only in accordance with the information provided in this documentation and with the locally applicable standards and directives. Any other application may cause personal injury or property damage.
9. The type label must remain permanently attached to the product.

## 2.2 Important safety information

### **DANGER**

Danger to life due to electric shock when live components or cables are touched

- All work on the inverter must only be carried out by qualified personnel who have read and fully understood all safety information contained in this manual.
- Do not open the inverter.
- Children must be supervised to ensure that they do not play with the inverter.

### **DANGER**

Danger to life due to high voltages of the PV array

When exposed to sunlight, the PV array generates dangerous DC voltage which is present in the DC conductors and the live components of the inverter. Touching the DC conductors or the live components can lead to lethal electric shocks. If you disconnect the DC connectors from the inverter under load, an electric arc may occur leading to electric shock and burns.

- Do not touch non-insulated cable ends.
- Do not touch the DC conductors.
- Do not touch any live components of the inverter.
- Have the inverter mounted, installed and commissioned only by qualified persons with the appropriate skills.
- If an error occurs, have it rectified by qualified persons only.
- Prior to performing any work on the inverter, disconnect it from all voltage sources as described in this document (see Section 9 "Disconnecting the Inverter from Voltage Sources").



## WARNING

Risk of injury due to electric shock

Touching an ungrounded PV module or array frame can cause a lethal electric shock.

- connect and ground the PV modules, array frame and electrically conductive surfaces so that there is continuous conduction.



## CAUTION

Risk of burns due to hot enclosure parts

Some parts of the enclosure can get hot during operation.

- During operation, do not touch any parts other than the enclosure lid of the inverter.

## NOTICE









Damage to the inverter due to electrostatic discharge

Internal components of the inverter can be irreparably damaged by electrostatic discharge.

- Ground yourself before touching any component.

### 2.3 Symbols on the label

Symbol	Explanation
	<p>Beware of a danger zone</p> <p>This symbol indicates that the inverter must be additionally grounded if additional grounding or equipotential bonding is required at the installation site.</p>

	<p>Beware of high voltage and operating current</p> <p>The inverter operates at high voltage and current. Work on the inverter must only be carried out by skilled and authorized electricians.</p>
	<p>Beware of hot surfaces</p> <p>The inverter can get hot during operation. Avoid contact during operation.</p>
	<p>WEEE designation</p> <p>Do not dispose of the inverter together with the household waste but in accordance with the disposal regulations for electronic waste applicable at the installation site.</p>
	<p>CE marking</p> <p>The product complies with the requirements of the applicable EU directives.</p>
	<p>Certification mark</p> <p>The product has been tested by TUV and got the quality certification mark.</p>
	<p>RCM Mark</p> <p>The product complies with the requirements of the applicable Australian standards.</p>
	<p>Capacitors discharge</p> <p>Before opening the covers, the inverter must be disconnected from the grid and PV array. Wait at least 5 minutes to allow the energy storage capacitors to fully discharge.</p>
	<p>Observe the documentation</p> <p>Observe all documentation supplied with the product</p>

# 3 Unpacking

## 3.1 Scope of delivery

Obj	Description	Quantity
A	Inverter	1 piece
B	Wall bracket	1 piece
C	DC connector	2 pairs(3-10K), 3 pairs(12-15K), 4 pairs(17-20K)
D	AC connector	1 piece
E	Documentation	1 piece
F	Screw accessory	1 piece
G	4G/ WiFi Stick	1 piece
H	Communication Cover	2 pieces



Inverter x1



Wall mounting bracket x1



DC connector  
3~10KW:2+2  
12~15KW:3+3  
17~20KW:4+4



AC connector x1



Documentation x1



Screw accessory x1



4G/WiFi stick x1



Rs485 Communication client x2

Please carefully check all the components in the carton. If anything is missing, contact your dealer at once.



## 3.2 Check for transport damage

---

Thoroughly inspect the packaging upon delivery. If you detect any damage to the packaging which indicates the inverter may have been damaged, inform the responsible shipping company immediately. We will be glad to assist you if required.

## 4 Mounting

---

### 4.1 Requirements for mounting

---

#### **DANGER**

Danger to life due to fire or explosion

Despite careful construction, electrical devices can cause fires.

- Do not mount the inverter on flammable construction materials.
- Do not mount the inverter in areas where flammable materials are stored.
- Do not mount the inverter in areas where there is a risk of explosion.

1. Be sure that the inverter is mounted out of the reach of children.
2. Mount the inverter in areas where it cannot be touched inadvertently.
3. Ensure good access to the inverter for installation and possible service.
4. The ambient temperature should be below 40°C to ensure optimal operation.
5. Observe the minimum clearances to walls, other inverters, or objects as follows to ensure sufficient heat dissipation.

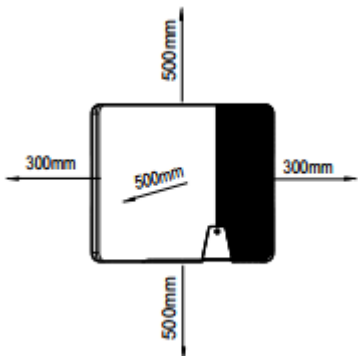

Direction	Min. clearance (mm)
above	500
below	500
sides	300

### Clearances for one inverter

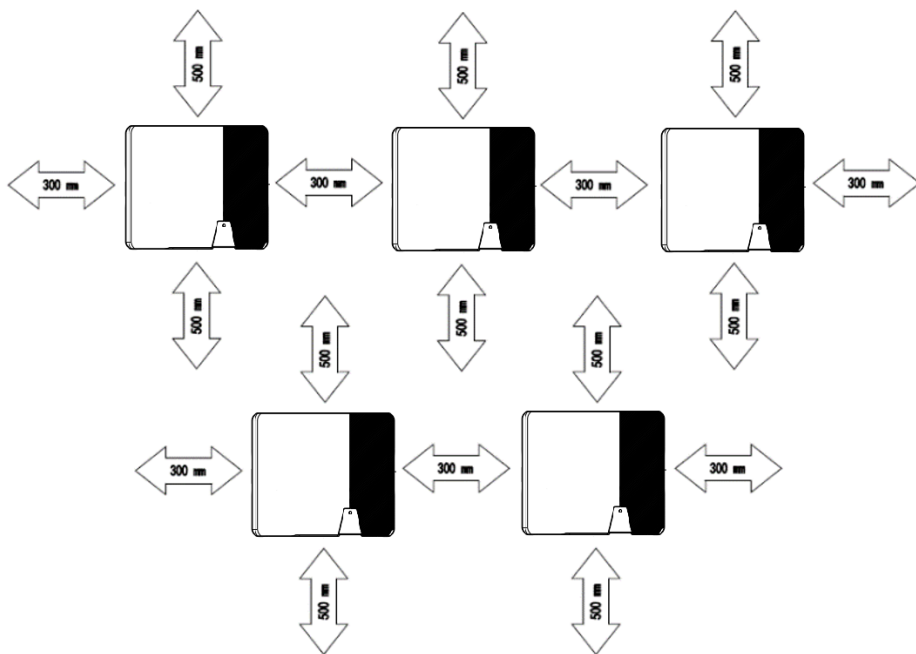

### Clearances for multiple inverters

- In order to avoid power reduction caused by overheating, do not mount the inverter in a location that allows long-term exposure to direct sunlight.
- Ensure optimum operation and extend service life, avoid exposing the inverter to direct sunlight, rain and snow.

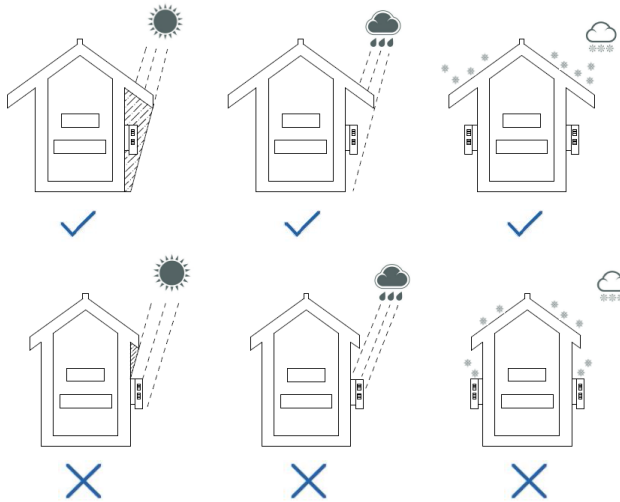

8. The mounting method, location and surface must be suitable for the inverter's weight and dimensions.
9. If mounted in a residential area, we recommend mounting the inverter on a solid surface. Plasterboard and similar materials are not recommended due to audible vibrations when in use.
10. Don't put any objects on the inverter. Do not cover the inverter.
11. Mount the inverter vertically or tilted backward by max.15°.

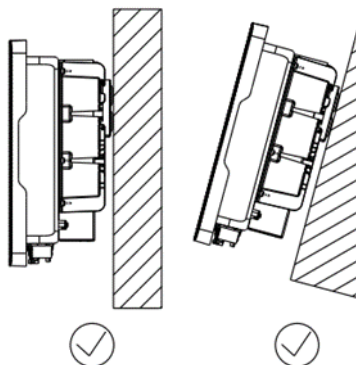

12. Never install the inverter horizontally, or with a forward tilt or with a backward tilt or even with upside down. The horizontal installation can result in damage to the inverter.

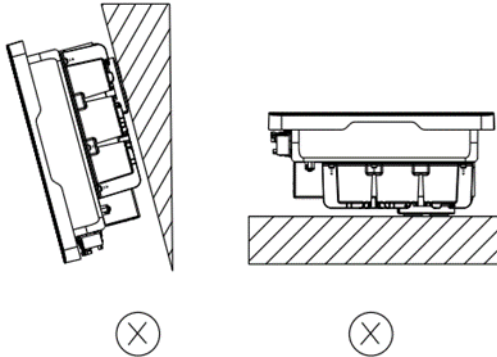

13. Mount the inverter at eye level for easy inspection.

## 4.2 Mounting the inverter

### **⚠ CAUTION**

Risk of injury when lifting the inverter, or if it is dropped

The weight of Solplanet inverter is max. 18.6 kg. There is risk of injury if the inverter is lifted incorrectly or dropped while being transported or when attaching it to or removing it from the wall bracket.

- Transport and lift the inverter carefully.

Mounting procedure:

### **⚠ CAUTION**

Risk of injury due to damaged cables

There may be power cables or other supply lines (e.g. gas or water) routed in the wall.

- Ensure that no lines are laid in the wall which could be damaged when drilling holes.

1. Use the wall bracket as a drilling template and mark the positions of the drill holes, then drill 3 holes ( $\Phi 10$ ) to a depth about 70mm. During operation, keep the drill vertical to the wall, and hold the drill steady to avoid tilted holes.

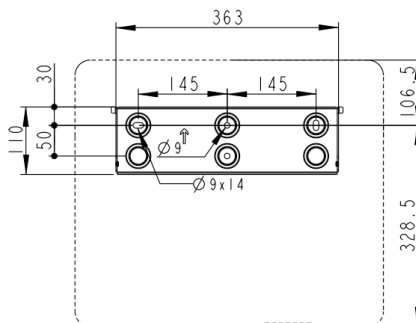

## CAUTION

Risk of injury due to the product falls down

If the depth and distance of the holes is not correct, the product maybe fall down from the wall.

- Before inserting the wall anchors, measure the depth and distance of the holes.

2. After cleaning the dust and other objects from the holes, place 3 wall anchors into the holes, then attach the wall bracket to the wall using the hexagon head screw delivered with the inverter.

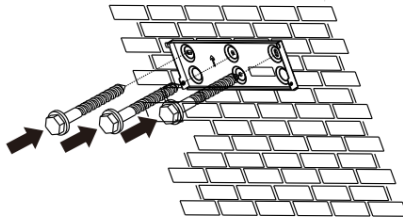

3. Hold the inverter using the handles at the corners, attach the inverter onto the wall bracket tilted slightly downwards.

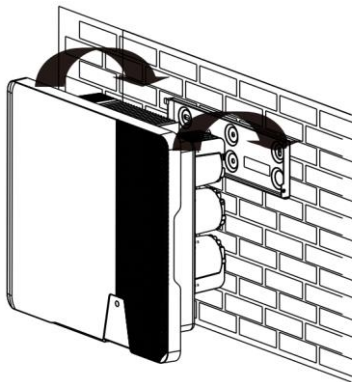

4. Check both sides of the outer fin of the inverter to ensure that it is securely in place.

5. Attach the outer fins of heat sink to both sides of the wall bracket using M4 screws. (screw driver type: PH2, torque: 1.6 Nm).

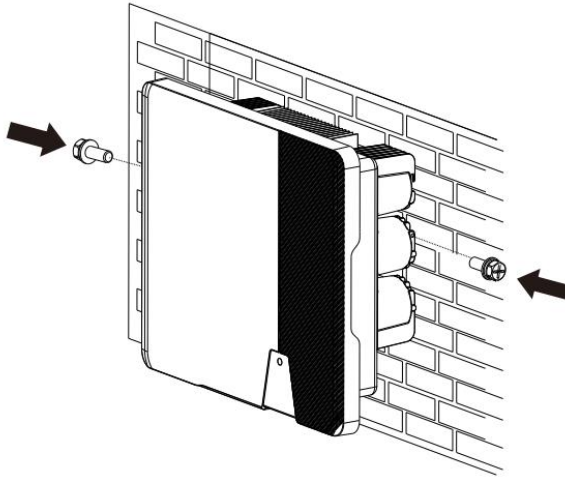

Dismante the inverter in reverse order.



## 5 Electrical connection

---

### 5.1 Safety

---

#### **DANGER**

Danger to life due to high voltages of the PV array

When exposed to sunlight, the PV array generates dangerous DC voltage which is present in the DC conductors and the live components of the inverter. Touching the DC conductors or the live components can lead to lethal electric shocks. If you disconnect the DC connectors from the inverter under load, an electric arc may occur leading to electric shock and burns.

- Do not touch non-insulated cable ends.
- Do not touch the DC conductors.
- Do not touch any live components of the inverter.
- Have the inverter mounted, installed and commissioned only by qualified persons with the appropriate skills.
- If an error occurs, have it rectified by qualified persons only.
- Prior to performing any work on the inverter, disconnect it from all voltage sources as described in chapter 9.

#### **WARNING**

Risk of injury due to electric shock

Touching an ungrounded PV module or array frame can cause a lethal electric shock.

- connect and ground the PV modules, array frame and electrically conductive surfaces so that there is continuous conduction.

## 5.2 Electrical Connection Panel

---

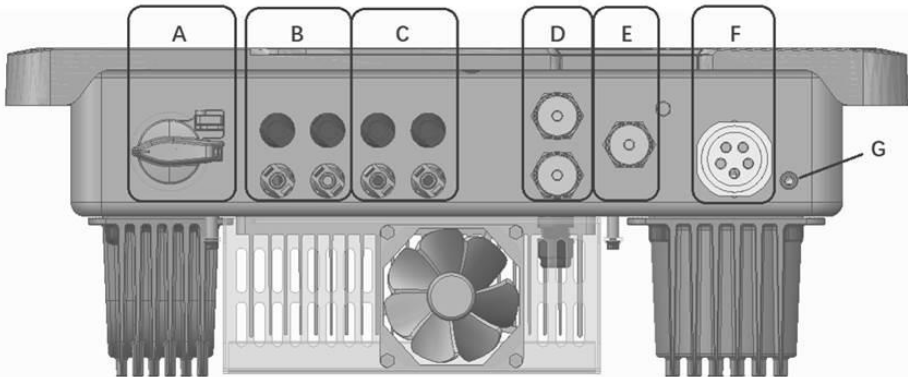

Object	Description
A	DC-switch
B	MPP1 connector (3-10K has 1 pair of terminals, 12K-20K has 2 pairs of terminals)
C	MPP2 connector (3K-15K has 1 pair of terminals, 17K-20K has 2 pairs of terminals)
D	RS485 Communication interface COM1/2
E	Communication Stick interface COM3
F	AC connector
G	Additional grounding screw

## 5.3 Electrical connection diagram with a separate DC isolator

Local standards or codes may require that a separate DC isolator should be installed next to the inverter. The separate DC isolator must disconnect each PV string of the inverter so that the entire inverter can be removed if the inverter is faulty. We recommend the following electrical connection:

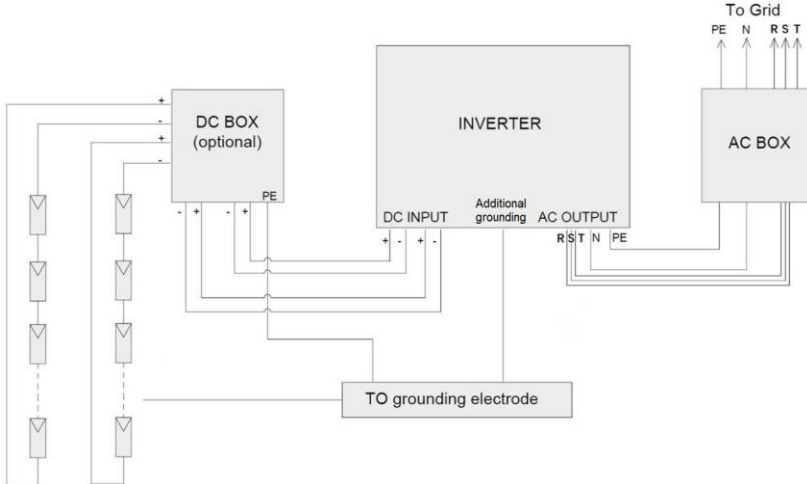

## 5.4 AC Connection

### 5.4.1 Conditions for the AC connection

#### Cable Requirements

The grid connection is made using 5 conductors (L1, L2, L3, N, and PE). We recommend the following requirements for stranded copper conductor.

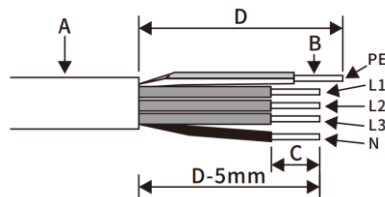

Object	Description	Value
A	External diameter	10...16 mm
B	Conductor cross-section	2.5...6 mm <sup>2</sup>
C	Stripping length of the insulated conductors	Approx. 13 mm
D	Stripping length of the AC cable's outer sheath	Approx.53 mm
The PE insulated conductor must be 2 mm longer than the L and N conductors		

Larger cross-sections should be used for longer leads.

### **Cable Design**

The conductor cross-section should be dimensioned to avoid power loss in cables exceeding 1% of rated output power.

The required conductor cross-section depends on the inverter rating, ambient temperature, routing method, cable type, cable losses, valid installation requirements of installation side.

### **Residual current protection**

The product is equipped with an integrated universal current-sensitive residual current monitoring unit inside. The inverter will disconnect immediately from the mains power as soon as fault current with a value exceeding the limit.



If an external residual-current protection device is required, please install a type B residual-current protection device with a protection limit of not less than 100mA.

### **Overvoltage category**

The inverter can be used in grids of overvoltage category III or lower in accordance with IEC 60664-1. This means that it can be permanently

connected at the grid-connection point in a building. In installations involving long outdoor cable routing, additional measures to reduce overvoltage category IV to overvoltage category III are required.

### **AC circuit breaker**

In PV systems with multiple inverters, protect each inverter with a separate circuit breaker. This will prevent residual voltage being present at the corresponding cable after disconnection.

No consumer load should be applied between AC circuit breaker and the inverter.

The selection of the AC circuit breaker rating depends on the wiring design (wire cross-section area), cable type, wiring method, ambient temperature, inverter current rating, etc. Derating of the AC circuit breaker rating may be necessary due to self-heating or if exposed to heat.

The maximum output current and the maximum output overcurrent protection of the inverters can be found in section 10 "Technical data".

### **Grounding conductor monitoring**

The inverter is equipped with a grounding conductor monitoring device. This grounding conductor monitoring device detects when there is no grounding conductor connected and disconnects the inverter from the utility grid if this is the case. Depending on the installation site and grid configuration, it may be advisable to deactivate the grounding conductor monitoring. This is necessary, for example, in an IT system if there is no neutral conductor present and you intend to install the inverter between two line conductors. If you are uncertain about this, contact your grid operator or AISWEI.



Safety in accordance with IEC 62109 when the grounding conductor monitoring is deactivated.

In order to guarantee safety in accordance with IEC 62109 when the grounding conductor monitoring is deactivated, carry out one of the following measures:

- Connect a copper-wire grounding conductor with a cross-section of at least 10 mm<sup>2</sup> to the AC connector bush insert.
- Connect an additional grounding that has at least the same cross-section as the connected grounding conductor to the AC connector bush insert.

This prevents touch current in the event of the grounding conductor on the AC connector bush insert failing.

#### 5.4.2 Grid connection

---

Procedure:



Danger to life due to high voltages in the inverter

Touching the live components can lead to lethal electric shocks.

- Before performing the electrical connection, ensure that the AC circuit-breaker is switched off and cannot be reactivated.

1. Switch off the AC circuit breaker and secure it against reconnection.
2. Insert the copper wire into a suitable European style tube connector (according to DIN 46228-4) and crimp it.

## NOTICE

Damage to the inverter due to wrong wiring

If the phase line was connected to PE terminal, the inverter will not function properly.

- Please ensure that the type of the conductors matches the signs of the terminals on the socket element.

3. Insert the grounding wire (PE), neutral wire (N) and live wire (L1, L2 and L3) of the crimped European connector into the corresponding holes of the terminal block as indicated by the arrows below, and tighten the screws with a 3mm wide Allen wrench. The torque is 2.0 Nm.

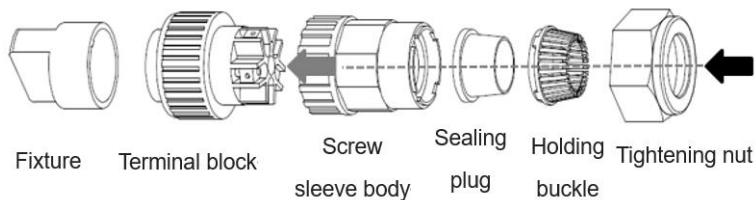

4. Push the holding buckle and the sealing plug into the screw sleeve body, and then assemble the terminal block, the screw sleeve body and the tightening nut together. First clamp the terminal block with a plastic clamp, then screw the screw sleeve body onto the terminal block, and finally tighten the tightening nut.

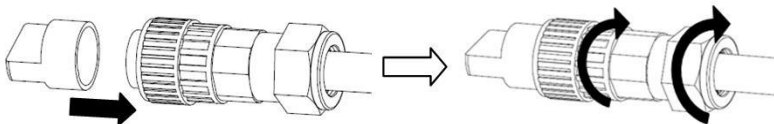

5. Insert the wired AC connector into the corresponding AC output port of the inverter and tighten it clockwise..

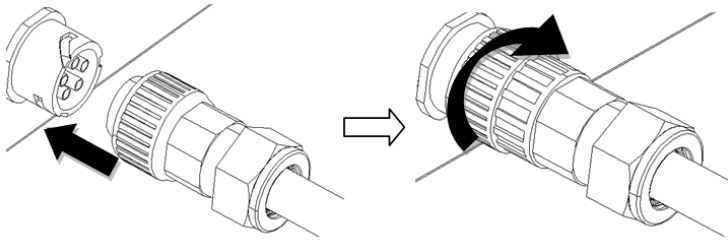

### 5.4.3 Additional grounding connection

If additional grounding or equipotential bonding is required locally, you can connect additional grounding to the inverter. This prevents touch current if the grounding conductor on the AC connector fails.

Procedure:

1. Align the terminal lug with protective conductor.
2. Insert the screw through the hole located at the housing and tighten it firmly (screw driver type: PH2, torque: 2.5Nm).

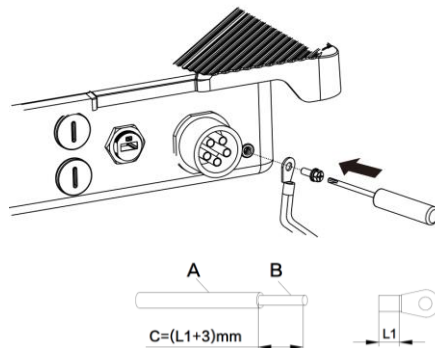

Grounding parts information :

Object	Explanation
1	M5 screw
2	M5 OT terminal
3	Yellow-green grounding wire



## 5.5 DC connection

---

### **DANGER**

Danger to life due to high voltages in the inverter

Touching the live components can lead to lethal electric shocks.

- Before connecting the PV generator, ensure that the DC-switch is switched off and that it cannot be reactivated.
- Do not disconnect the DC connectors under load.

### 5.5.1 Requirements for the DC connection

---

Requirements for the PV modules of a string:

- PV modules of the connected string must be the same type, identical alignment and identical tilt.
- The thresholds for the input voltage and the input current of the inverter must be adhered to (see Section 10.1 "Technical DC input data").
- On the coldest day based on statistical records, the open-circuit voltage of the PV array must never exceed the maximum input voltage of the inverter.
- The connection cables of the PV modules must be provided with the connectors
- The positive connection cables of the PV modules must be fitted with the positive DC connectors. The negative connection cables of the PV modules must be provided with the negative DC connectors.

## 5.5.2 Assembling the DC connectors

### DANGER

Danger to life due to high voltages on DC conductors

When exposed to sunlight, the PV array generates dangerous DC voltage which is present in the DC conductors. Touching the DC conductors can lead to lethal electric shocks.

- Cover the PV modules.
- Do not touch the DC conductors.

Assemble the DC connectors as described below. Be sure to observe the correct polarity. The DC connectors are marked with the symbols "+" and " - ".

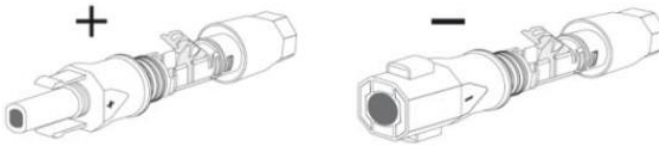

Cable requirements:

The cable must be of type PV1-F, UL-ZKLA or USE2 and comply with the following properties:

- External diameter: 5-8mm
- Conductor cross-section: 2.5-6mm<sup>2</sup>
- Qty single wires: minimum 7
- Nominal voltage: minimum 1100V

Procedure:

1. Strip about 12 mm of the cable insulation.

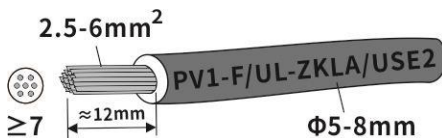

2. Route the stripped cable all the way into the DC connector. Ensure that

the stripped cable and the DC connector have the same polarity.

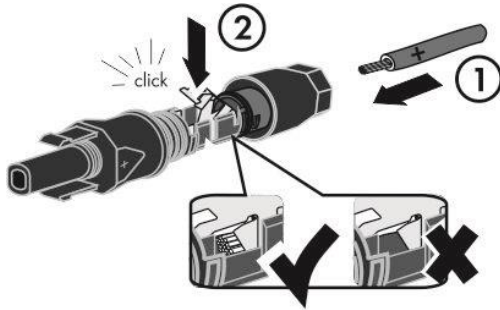

3. Push the swivel nut up to the thread and tighten the swivel nut. (SW15, Torque: 2.0Nm)

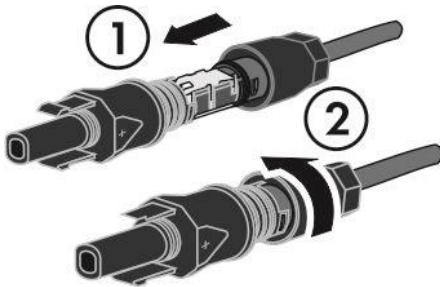

### 5.5.3 Disassembling the DC connectors

#### **⚠ DANGER**

Danger to life due to high voltages on DC conductors  
When exposed to sunlight, the PV array generates dangerous DC voltage which is present in the DC conductors. Touching the DC conductors can lead to lethal electric shocks.

- Cover the PV modules.
- Do not touch the DC conductors.

Procedure:

1. Make sure DC power is cut off.
2. Unscrew the swivel nut.



3. To release the DC connector, insert a flat-blade screwdriver (blade width: 3.5 mm) into the side catch mechanism and lever open.

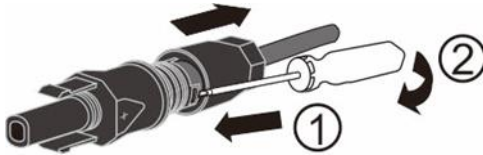

4. Carefully pull the DC connector apart.
5. Release the clamping bracket. To do so, insert a flat-blade screwdriver (blade width: 3.5 mm) into the clamping bracket and lever it open.

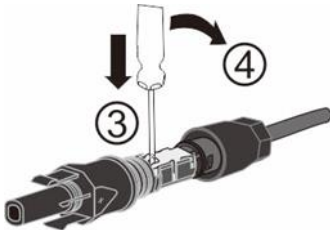

6. Remove the cable.



## 5.5.4 Connecting the PV Array

---

### **NOTICE**

Destruction of the inverter due to overvoltage

If the voltage of the strings exceeds the maximum DC input voltage of the inverter, it can be destroyed due to overvoltage. All warranty claims become void.

- Do not connect strings with an open-circuit voltage greater than the maximum DC input voltage of the inverter.
- Check the design of the PV system

Procedure:

1. Ensure that the individual AC circuit breaker is switched off and secure it against reconnection.
2. Ensure that the DC-switch is switched off and secure it against reconnection.
3. Ensure that there is no ground fault in the PV strings.
4. Check whether the DC connector has the correct polarity. If the DC connector fits with a DC cable having the wrong polarity, the DC connector must be reassembled again. The DC cable must always have the same polarity as the DC connector.
5. Ensure that the open-circuit voltage of the PV strings does not exceed the maximum DC input voltage of the inverter.
6. Unplug the sealing plug on the input end of the DC connector and connect the assembled DC connectors to the inverter until they audibly snap into place. Do not unplug the sealing plug from the input end of unused DC connector.

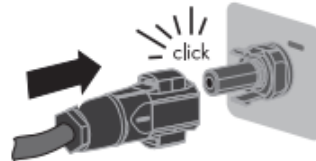
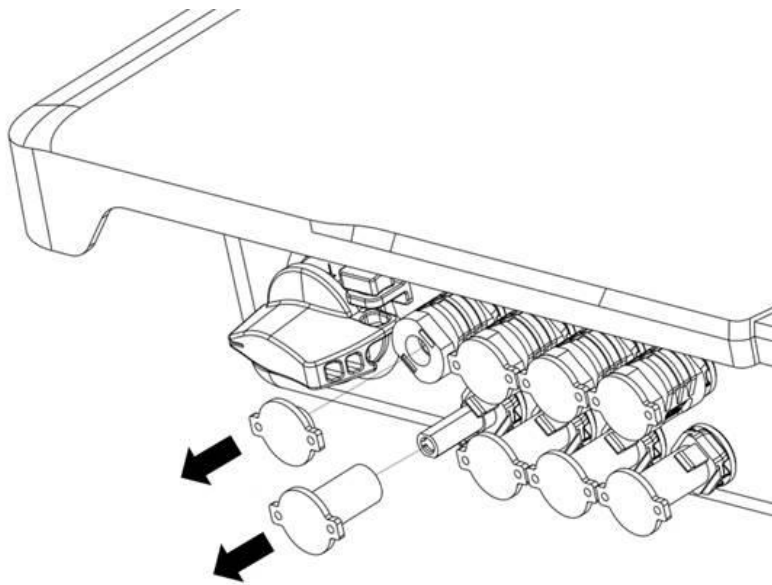

## **NOTICE**

Damage to the inverter due to moisture and dust penetration  
Seal the unused DC inputs with sealing plugs so that moisture and dust cannot penetrate the Inverter.

- Make sure all DC connectors are securely sealed.

## 5.6 Communication equipment connection

### 5.6.1 Mounting the WiFi or 4G Stick

#### **NOTICE**

Damage to the inverter due to electrostatic discharge  
Internal components of the inverter can be irreparably damaged by electrostatic discharge.

- Ground yourself before touching any component.

When the system uses WiFi Stick or 4G Stick monitoring, WiFi Stick or 4G Stick should be connected to COM3 connection in section 5.2.

Procedure:

1. Take out the WiFi Stick included in the scope of delivery.
2. Attach the WiFi Stick to the connection port in place and tighten it into the port by hand with the nut in the stick. Make sure the stick is securely connected and the label on the modular can be seen.

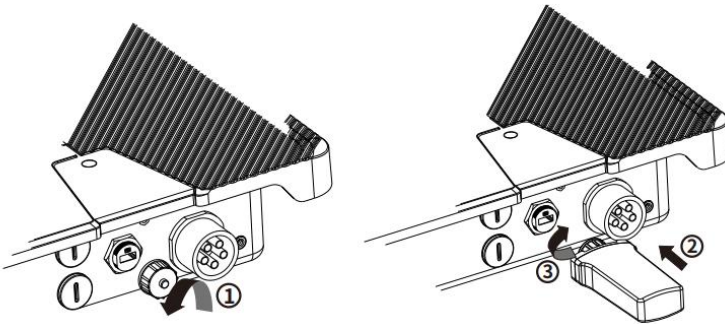

The communication stick interface COM3 is only applicable to AISWEI products and can not be connected to any other USB devices.

## 5.6.2 Connect the RS485 network cable

### **NOTICE**

The inverter can be destroyed by wrong communication wiring

- Internal components of the inverter can be irreparably damaged due to incorrect wiring between the power wire and signal wire. All the warranty claim will be invalid.
- Please check the wiring of the RJ45 connector before crimping the contact.

This inverter is equipped with RJ45 interfaces for RS485 communication. The network cable should be connected to COM1/2 connection in section 5.2.

Pinout detail of the RJ45 interface on the inverter as follows:

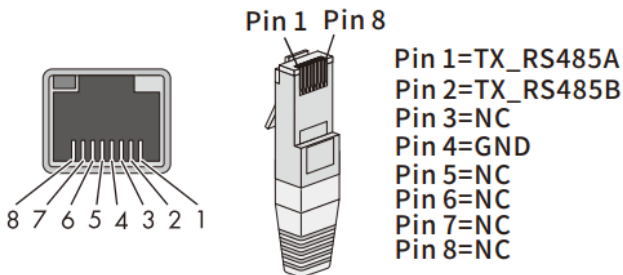

The network cable meeting the EIA/TIA 568A or 568B standard must be UV resistant if it is to be used outdoors.

Cable requirement:

- Shielding wire
- CAT-5E or higher
- UV-resistant for outdoor use
- RS485 cable maximum length 1000m

Procedure:

1. Take out the communication cover from the package.
2. Screw on the cover cap of the signal terminal according to the sequence of



the following arrows and plug the correctly connected wire into the waterproof RS485 communication client in the optional accessories.

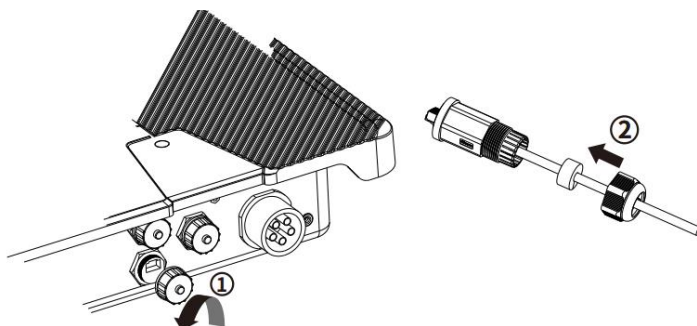

3. Insert the cable into the corresponding communication connector in the order of the arrow, tighten the sleeve and the forcing head screw at the tail.

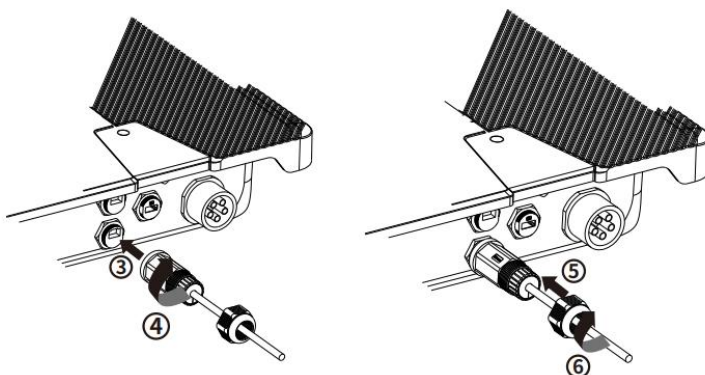

## **NOTICE**

Damage to the inverter due to moisture and dust penetration

- If the cable gland are not mounted properly, the inverter can be destroyed due to moisture and dust penetration. All the warranty claim will be invalid.
- Make sure the cable gland has been tightened firmly.

Disassemble the network cable in reverse order.

### 5.6.3 Connect the smart meter cable

---

If smart meter needs to be connected. Cable requirements and connecting procedure are the same as chapter 5.6.2.

# 6 Communication

## 6.1 System monitoring via WLAN

User can monitor the inverter through the external 4G/WiFi stick module. The connection diagram between the the inverter and internet is shown as following two pictures, both two methods are available. Please note that each 4G/WiFi stick can only connect to 5 inverters in method1.

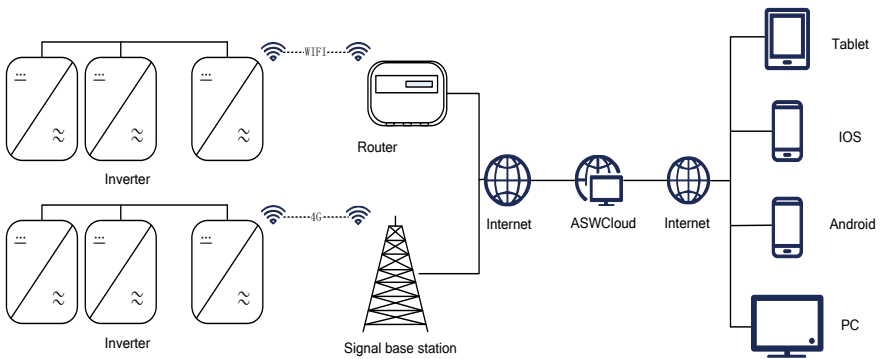

Method 1 only one inverter with the 4G/WiFi Stick, the other inverter be connected through the RS 485 cable.

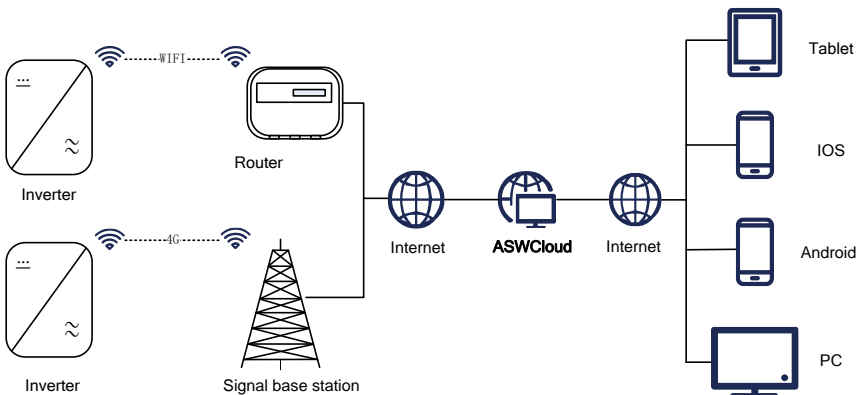

Mehod 2 every inverter with 4G/WiFi Stick, every inverter can connect to internet.

As shown above, we offer a remote monitoring platform called “AiSWEI cloud”. You can also install the “AiSWEI APP” on a smart phone using Android or an iOS operating system. You can visit the website ( <https://solplanet.net/installer-area/#monitoring>) for system information. And download the user manual for the AISWEI Cloud Web or AISWEI APP.

## 6.2 Active power control with Smart meter

---

The inverter can control activepower output via connecting smart meter, following picture is the system connection mode through WiFi stick.

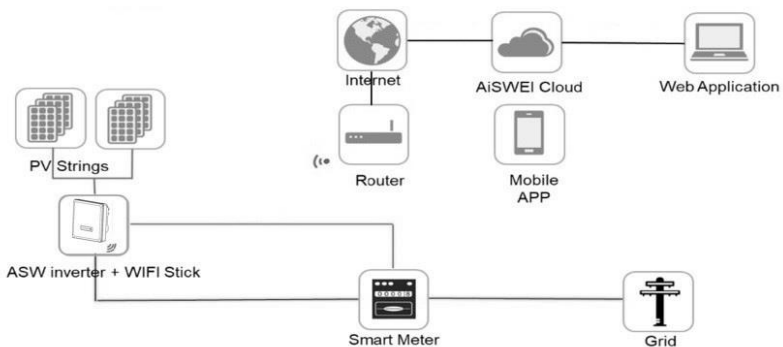

The smart meter should support the MODBUS protocol with a baud rate of 9600 and address set 1. Smart meter as above SDM630-Modbus connecting method and seting baud rate method for modbus please refer to it's user manual.



Possible reason of communication failure due to incorrect connection

- WiFi stick only support single inverter to do active power control.
- The overall length of the cable from inverter to smart meter is 100m.

The active power limit can be set on “AiSWEI APP” application, the details can be found in the user manual for the AISWEI APP.

### 6.3 Remote firmware update

---

ASW LT-G2-Pro series inverters can update the firmware through 4G/WIFI stick, no need to open the cover for maintenance. For more information, please contact the Service.

### 6.4 Active power control via demand response enabling device (DRED)

---



DRMs application description

- Only applicable to AS/NZS4777.2:2020.
- DRM0, DRM5, DRM6, DRM7, DRM8 are available.

The inverter shall detect and initiate a response to all supported demand response commands, demand response modes are described as follows:

Mode	Requirement
DRM 0	Operate the disconnection device

DRM 1	Do not consume power
DRM 2	Do not consume at more than 50% of rated power
DRM 3	Do not consume at more than 75% of rated power AND Source reactive power if capable
DRM 4	Increase power consumption (subject to constraints from other active DRMs)
DRM 5	Do not generate power
DRM 6	Do not generate at more than 50% of rated power
DRM 7	Do not generate at more than 75% of rated power AND Sink reactive power if capable
DRM 8	Increase power generation (subject to constraints from other active DRMs)

If DRMs support is required, the inverter should be used in conjunction with AiCom. the Demand Response Enabling Device (DRED) can be conneted to the DRED port on AiCom via RS485 cable. You can vist the website [www.solplanet.net](http://www.solplanet.net) for more information and download the user manual for the AiCom.

## 6.5 Communication with the third party device

---

Solplanet inverters can also connect with one third party device instead of RS485 or WiFi stick, the communication protocol is modbus. For more information, please contact the Service.

## 6.6 Earth fault alarm

---

This inverter complies with IEC 62109-2 clause 13.9 for earth fault alarm monitoring. If an Earth Fault Alarm occurs, the red color LED indicator will light up. At the same time, the error code 38 will be sent to the AISWEI Cloud. (This function is only available in Australia and New Zealand)

# 7 Commissioning

---

## 7.1 Electrical check

---

Carry out the main electrical checks as follows:

- ① Check the PE connection with a multimeter: check that the inverter's exposed metal surface has a grounding connection.

 **WARNING**

Danger to life due to the presence of DC-Voltage

Touching the live conductors can lead to lethal electric shocks.

- Only touch the insulation of the PV array cables.
- Do not touch parts of the sub-structure and frame of the PV array which isn't grounded.
- Wear personal protective equipment such as insulating gloves.

- ② Check the DC voltage values: make sure that the DC voltage of the strings does not exceed the permitted limits.
- ③ Check the polarity of the DC voltage: make sure the DC voltage has the correct polarity.
- ④ Check the PV generator's insulation to ground with a multimeter: make sure that insulation resistance to ground is greater than 1MΩ.



## WARNING

Danger to life due to the presence of AC-Voltage

Touching the live conductors can lead to lethal electric shocks.

- Only touch the insulation of the AC cables.
- Wear personal protective equipment such as insulating gloves.

- ⑤ Check the grid voltage: check that the grid voltage at the point of connection of the inverter is within the permitted range.

## 7.2 Mechanical check

---

Carry out the main mechanical checks to ensure the inverter is waterproof as follows:

- ① Make sure the inverter has been correctly mounted with wall bracket.
- ② Make sure the cover has been correctly mounted.
- ③ Make sure the communication cable and AC connector have been correctly wired and tightened.



## 7.3 Safety code check

---

Choose suitable safety code according to the location of installation. please visit website (<https://solplanet.net/installer-area/#monitoring>) and download the AISWEI Cloud APP manual for detailed information, you can find the Safety Code Setting Guide in an event where an installer needs to set the country code manually.



The Solplanet's inverters comply with local safety code when leaving the factory.

## 7.4 Start-up

---

After finishing the electrical and mechanical checks, switch on the miniature circuit-breaker and DC-switch in turn. Once the DC input voltage is sufficiently high and the grid-connection conditions are met, the inverter will start operation automatically. Usually, there are three states during operation:

- 1) Waiting: When the initial voltage of the strings is greater than the minimum DC input voltage but lower than the start-up DC input voltage, the inverter is waiting for sufficient DC input voltage and cannot feed power into the grid.
- 2) Checking: When the initial voltage of the strings exceeds the start-up DC input voltage, the inverter will check feeding conditions at once. If there is anything wrong during checking, the inverter will switch to the "Fault" mode.
- 3) Normal: After checking, the inverter will switch to "Normal" state and feed power into the grid.

During periods of low radiation, the inverter may continuously start up and shut down. This is due to insufficient power generated by the PV array. If this fault occurs often, please call service.



If the inverter is in “Fault” mode, refer to chapter 11 “Troubleshooting”.

## 8 Display

---

### 8.1 Overview of the control panel

---

The inverter is equipped with a display panel, which has 3 LED indicators.



### 8.2 LED indicators

---

The three LED indicators from top to bottom are:

1. SOLAR power indicator

When the inverter is in the standby self-checking state, the white light flashes. Under normal grid-connected working state, the light is always on. In “Fault” mode, the light is off.

2. COM communication indicator

When the inverter communicates with other devices normally, the white light flashes. If communication is abnormal or not connected, the light is off.

3.  Fault indicator

The light is on when the invert is faulty or when external conditions cannot be grid-connected or when it is working improperly. When there is no fault, the light is off

## 9 Disconnecting the inverter from voltage sources

---

Before performing any work on the inverter, disconnect it from all voltage sources as described in this section. Always adhere strictly to the given sequence.

1. Disconnect AC circuit breaker and secure against reconnection.
2. Disconnect the DC-switch and secure against reconnection.
3. Use a current probe to ensure that no current is present in the DC cables.

### **DANGER**

Danger to life due to electric shock when touching exposed DC conductors or DC plug contacts if the DC connectors are damaged or loose

The DC connectors can break or become damaged, become free of the DC cables, or no longer be connected correctly if the DC connectors are released and disconnected incorrectly. This can result in the DC conductors or DC plug contacts being exposed. Touching live DC conductors or DC plug connectors will result in death or serious injury due to electric shock.

- Wear insulated gloves and use insulated tools when working on the DC connectors.
- Ensure that the DC connectors are in perfect condition and that none of the DC conductors or DC plug contacts are exposed.
- Carefully release and remove the DC connectors as described in the following.

4. Release and remove all DC connectors. Insert a flat-blade screwdriver or an angled screwdriver (blade width: 3.5 mm) into one of the slide slots and pull the DC connectors out downwards. Do not pull on the cable.

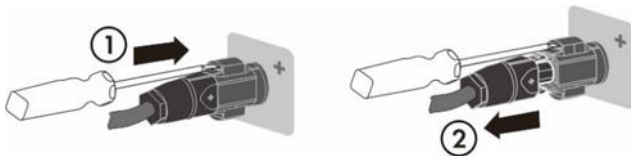

5. Release and disconnect the AC connector. Rotate the socket element counterclockwise to open.

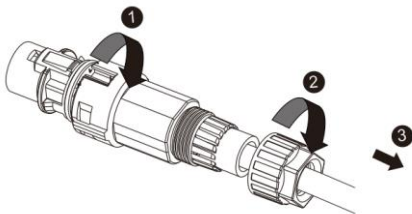

6. Wait until all LEDs and the display have gone out.

## 10 Technical data

### 10.1 DC input data

Type	ASW3K-LT-G2-Pro	ASW4K-LT-G2-Pro	ASW5K-LT-G2-Pro	ASW6K-LT-G2-Pro
Max. PV modules power (STC)	4500W	6000W	7500W	9000W
Max. input voltage/ Rated input voltage	1100V/630V			
MPPT voltage range	150~1000 V			
Full load MPPT voltage range	270~850 V			
Initial feed-in voltage	180V			
Min input voltage	125V			
Max. DC input current	16A/16A			
I <sub>sc</sub> PV, absolute max.	25A/25A			
Maximum reverse current from the inverter in the system for max. 1 ms	0A			
Number of MPP trackers	2			

Strings per MPP tracker	1/1
Overtoltage category in accordance with IEC60664-1	II

Type	ASW8K-LT-G2-Pro	ASW10K-LT-G2-Pro	ASW12K-LT-G2-Pro	ASW13K-LT-G2-Pro
Max. PV modules power (STC)	12000W	15000W	18000W	19500W
Max. input voltage/ Rated input voltage	1100V/630V			
MPPT voltage range	150~1000 V			
Full load MPPT voltage range	400~850 V			
Intital feed-in voltage	180V			
Min input voltage	125V			
Max. DC input current	20A/16A		32A/20A	
I <sub>sc</sub> PV, absolute max.	30A/25A		48A/30A	
Maximum reverse current from the	0A			



inverter in the system for max. 1 ms		
Number of MPP trackers	2	
Strings per MPP tracker	1/1	2/1
Overtoltage category in accordance with IEC60664-1	II	

Type	ASW15K-LT-G2-Pro	ASW17K-LT-G2-Pro	ASW20K-LT-G2-Pro
Max. PV modules Power (STC)	22500W	25500W	30000W
Max. input voltage/ Rated input voltage	1100V/630V		
MPP voltage range	150~1000 V		
Full load MPP voltage range	400~850V		
Intitial feed-in voltage	180V		
Min input voltage	125V		
Max. DC input current	32A/20A	2*32A	
I <sub>sc</sub> PV, absolute max.	48A/30A	2*48A	
Maximum reverse current from the inverter in the system for max. 1 ms	0A		

Number of MPP trackers	2	
Strings per MPP tracker	2/1	2/2
Overtoltage category in accordance with IEC60664-1	II	

(1) When the DC input voltage is greater than 1000V, the inverter will alarm an error.

(2) When the DC input voltage is lower than 995V, the inverter starts self-checking.

(3) The full-load MPP voltage range of the inverter is the value measured under the rated AC voltage. If you have any questions, please consult local service personnel.

## 10.2 AC output data

Type	ASW 3K-LT-G2-Pro	ASW 4K-LT-G2-Pro	ASW 5K-LT-G2-Pro	ASW 6K-LT-G2-Pro
Rated output power	3000W	4000 W	5000 W	6000 W
Max. output active power	3300W	4400 W	5500 W	6600 W
Max. output apparent power	3300VA	44000 VA	5500 VA	6600VA
Rated AC Voltage <sup>(1)</sup>	3/N/PE, 220/380 V, 230/400 V, 240/415 V			
AC voltage range	160 V~300 V			
Rated AC Frequency <sup>(2)</sup>	50 Hz/ 60 Hz			
Operating range at AC power frequency 50 Hz	45 Hz to 55Hz			
Operating range at AC power frequency 60 Hz	55 Hz to 65Hz			

Max. continuous output current	3x4.8 A	3x6.4 A	3x8.0 A	3x9.6 A
Maximum output current under fault conditions	3x14A			
Maximum output overcurrent protection	3x16A			
Adjustable displacement power factor	0.80 ind - 0.80 cap			
Inrush current (peak and duration)	<10A @250us			
Harmonic distortion (THD) at the rated power	< 3%			
Night-time power loss	<1 W			
Standby power loss	<12 W			
Overvoltage category in accordance with IEC60664-1	III			

Type	ASW 8K-LT-G2-Pro	ASW 10K-LT-G2-Pro	ASW 12K-LT-G2-Pro	ASW 13K-LT-G2-Pro
Rated output power	8000W	10000 W	12000 W	13000 W
Max. output active power	8800W	11000 W	13200 W	14300 W
Max. output apparent power	8800VA	11000 VA	13200 VA	14300VA
Rated AC Voltage <sup>(1)</sup>	3/N/PE, 220/380 V, 230/400 V,240/415 V			
AC voltage range	160 V~300 V			

Rated AC Frequency <sup>(2)</sup>	50 Hz/ 60 Hz			
Operating range at AC power frequency 50 Hz	45 Hz to 55Hz			
Operating range at AC power frequency 60 Hz	55 Hz to 65Hz			
Max. continuous output current	3x12.8 A	3x16 A	3x19.1 A	3x20.7 A
Maximum output current under fault conditions	3x25A		3x33A	
Maximum output overcurrent protection	3x32A		3x40A	
Adjustable displacement power factor	0.80 ind - 0.80 cap			
Inrush current (peak and duration)	<10A @250us			
Harmonic distortion (THD) at the rated power	< 3%			
Night-time power loss	<1 W			
Standby power loss	<12 W			
Oversoltage category in accordance with IEC60664-1	III			

Type	ASW 15K-LT-G2-Pro	ASW 17K-LT-G2-Pro	ASW 20K-LT-G2-Pro
Rated output power	15000 W	17000 W	20000 W

Max. output active power	16500 W	18700 W	22000W
Max. output apparent power	16500VA	18700VA	22000VA
Rated AC Voltage <sup>(1)</sup>	3/N/PE, 220/380 V, 230/400 V,240/415 V		
AC voltage range	160 V~300 V		
Rated AC Frequency <sup>(2)</sup>	50 Hz/ 60 Hz		
Operating range at AC power frequency 50 Hz	45 Hz to 55Hz		
Operating range at AC power frequency 60 Hz	55 Hz to 65Hz		
Max. continuous output current	3x24A	3x27.1 A	3x31.9 A
Maximum output current under fault conditions	3x33A	3x46A	
Maximum output overcurrent protection	3x40A	3x60A	
Adjustable displacement power factor	0.80 ind - 0.80 cap		
Inrush current (peak and duration)	<10A @250us		
Harmonic distortion (THD) at the rated power	< 3%		
Night-time power loss	<1 W		
Standby power loss	<12 W		
Overvoltage category in accordance with IEC60664-1	III		

(1) The AC voltage range depends on the local safety standards and rules.

(2) The AC frequency range depends on the local safety standards and rules.

## 10.3 General data

Type	ASW 3K-10K-LT-G2-Pro	ASW 12K-15K-LT-G2-Pro	ASW 17/20K-LT-G2-Pro
Net weight	16 KG	17.3 KG	18.6KG
Dimensions(LxWxD)	503x435x183 mm		
Mounting environment	Indoor and Outdoor		
Mounting recommendation	Wall bracket		
Operating temperature range	-25...+60°C		
Max. permissible value for relative humidity ( non-condensing )	100%		
Max. operating altitude above mean sea level	3000m		
Ingress protection	IP65 according to IEC60529		
Climatic category	4K4H		
Protection class	I according to IEC 62103		
Topology	Transformerless		
Feed-in phases	3		
Cooling concept	Natural convection	Active cooling	
Display	LED		
Communication interfaces	WiFi/4G/RS485(optional)		
Radio technology	WLAN 802.11 b / g / n		
Radio spectrum	WLAN 2.4 GHz with 2412MHz – 2472MHz band		
Antenna gain	2dB		

## 10.4 Safety regulations

Type	ASW LT-G2-Pro Series inverter
Internal overvoltage protection	Integrated
DC insulation monitoring	Integrated
DC injection monitoring	Integrated
Grid monitoring	Integrated
Residual current monitoring	Integrated
Islanding protection	Integrated (Three-phase monitoring)
EMC immunity	EN61000-6-1 EN61000-6-2
EMC emission	EN61000-6-3 EN61000-6-4
Utility interference	EN61000-3-2, EN61000-3-3 EN61000-3-11, EN61000-3-12

## 10.5 Tools and torque

Tools and torque required for installation and electrical connections.

Tools, model		Object	Torque
Torque screwdriver, T25		Screws for the cover	3.0 Nm
Torque screwdriver, T20		Screws for wall bracket Screw for second grounding	1.6Nm
Flat-head screwdriver, blade with 3.5mm		Sunclix DC connector	/
Torque screwdriver, PH2 Cross head		Screw for second protective grounding connection	1.6Nm
Flat-head screwdriver, blade 0.4x2.5		Smart meter connector	/
/		Stick	Hand-tight
Socket wrench	Open end of 33	Swivel nut of M25 cable gland	Hand-tight
	Open end of 15	Swivel nut of sunclix connector	2.0Nm
Wire stripper		Peel cable jackets	/
Crimping tools		Crimp power cables	/
Hammer drill, drill bit of Ø10		Drill holes on the wall	/
Rubber mallet		Hammer wall plugs into holes	/
Cable cutter		Cut power cables	/
Multimeter		Check electrical connection	/
Marker		Mark the positions of drill holes	/



ESD glove	Wear ESD glove when opening the inverter	/
Safety goggle	Wear safety goggle during drilling holes.	/
Anti-dust respirator	Wear anti-dust respirator during drilling holes.	/

# 11 Troubleshooting

When the PV system does not operate normally, we recommend the following solutions for quick troubleshooting. If an error occurs, the red LED will light up. There will have "Event Messages" display in the monitor tools. The corresponding corrective measures are as follows:

Object	Error code	Corrective measures
Presumable Fault	E33	<ul style="list-style-type: none"> <li>• Check the grid frequency and observe how often major fluctuations occur.</li> </ul> <p>If this fault is caused by frequent fluctuations, try to modify the operating parameters after informing the grid operator first.</p>
	E34	<ul style="list-style-type: none"> <li>• Check the grid voltage and grid connection on inverter.</li> <li>• Check the grid voltage at the point of connection of inverter.</li> </ul> <p>If the grid voltage is outside the permissible range due to local grid conditions, try to modify the values of the monitored operational limits after informing the electric utility company first.</p> <p>If the grid voltage lies within the permitted range and this fault still occurs, please call service.</p>
	E35	<ul style="list-style-type: none"> <li>• Check the fuse and the triggering of the circuit breaker in the distribution box.</li> <li>• Check the grid voltage, grid usability.</li> <li>• Check the AC cable, grid connection on the inverter.</li> </ul> <p>If this fault is still being shown, contact the service.</p>
	E36	<ul style="list-style-type: none"> <li>• Make sure the grounding connection of the inverter is reliable.</li> <li>• Make a visual inspection of all PV cables and</li> </ul>

Presumable Fault		modules. If this fault is still shown, contact the service.
	E37	<ul style="list-style-type: none"> <li>• Check the open-circuit voltages of the strings and make sure it is below the maximum DC input voltage of the inverter.</li> </ul> <p>If the input voltage lies within the permitted range and the fault still occurs, please call service.</p>
	E38	<ul style="list-style-type: none"> <li>• Check the PV array's insulation to ground and make sure that the insulation resistance to ground is greater than 1 MOhm. Otherwise, make a visual inspection of all PV cables and modules.</li> <li>• Make sure the grounding connection of the inverter is reliable.</li> </ul> <p>If this fault occurs often, contact the service.</p>
	E40	<ul style="list-style-type: none"> <li>• Check whether the airflow to the heat sink is obstructed.</li> <li>• Check whether the ambient temperature around the inverter is too high.</li> </ul>
	E46	<ul style="list-style-type: none"> <li>• Check whether the open circuit voltage of each photovoltaic group is <math>\geq 1020V</math>.</li> </ul> <p>If the open circuit voltage of each pv group is less than 995V and this fault still exists, please contact the service personnel.</p>
	E48	<ul style="list-style-type: none"> <li>• Check whether the electric supply is abnormal.</li> </ul> <p>If the electric supply is normal and this fault still exists, please contact the service personnel.</p>
	E56 E57 E58	<ul style="list-style-type: none"> <li>• Disconnect the inverter from the grid and the PV array and reconnect after 3 minutes.</li> </ul> <p>If this fault is still being shown, contact the service.</p>
	E61 E62	<ul style="list-style-type: none"> <li>• Check the DRED device communication or operation.</li> </ul>
	E65	<ul style="list-style-type: none"> <li>• Make sure the grounding connection of the inverter</li> </ul>

		is reliable. If this fault occurs often, contact the service.
Permanent Fault	E01 E03 E05 E07	• Disconnect the inverter from the utility grid and the PV array and reconnect it after LED turn off. If this fault is still being displayed, contact the service.
Permanent Fault	E08 E10	

Warning code	Warning message
31	PV1 input over voltage
32	PV2 input over voltage
34	PV1 input over current-software
35	PV1 input over current-hardware
36	PV2 input over current-software
37	PV2 input over current-hardware
40	BUS over voltage-software
42	BUS voltage unbalance (for three phase inverter)
44	Grid voltage over instant
45	Output over current-software
46	Output over current-hardware
47	Anti-islanding
150	PV1-SPD Fault
156	Inter Fan abnormal
157	External Fan abnormal
163	GFCI Redundancy check
166	CPU self-test --register abnormal
167	CPU self-test --RAM abnormal
174	Low Air Temperature

# 12 Maintenance

---

Normally, the inverter needs no maintenance or calibration. Regularly inspect the inverter and the cables for visible damage. Disconnect the inverter from all power sources before cleaning. Clean the housing, cover and display with a soft cloth. Ensure the heatsink at the rear of the inverter cover is not covered.

## 12.1 Cleaning the contacts of the DC-switch

---

Clean the contacts of the DC-switch once per year. Perform cleaning by cycling the switch to ON/OFF positions 5 times. The DC-switch is located at the lower left of the housing.

## 12.2 Cleaning the heat sink

---

### CAUTION

Risk injury due to hot heat sink

The heat sink may exceed 70°C during operation.

- Do not touch the heatsink during operation.
- Wait approx. 30 minutes before cleaning until the heatsink has cooled

An external fan is installed at the bottom of the inverter. When the fan fails to work normally, the inverter cannot effectively dissipate heat, and the load drops or the machine may even shut down. At this time, the fan needs to be cleaned or replaced.

Clean the heat sink with pressurized air or a soft brush. Do not use aggressive chemicals, cleaning solvents or strong detergents.

For proper function and long service life, ensure free air circulation around the heatsink.

## 13 Recycling and disposal

---

Dispose of the packaging and replaced parts according to the rules at the installation site where the device is installed.



Do not dispose of the product together with the household waste but in accordance with the disposal regulations for electronic waste applicable at the installation site.

## 14 EU Declaration of Conformity

---

within the scope of the EU directives

- Electromagnetic compatibility 2014/30/EU (L 96/79-106, March 29,2014) (EMC).
- Low Voltage Directive 2014/35/EU.(L 96/357-374, March 29, 2014)(LVD).
- Radio Equipment Directive 2014/53/EU (L 153/62-106. May 22. 2014) (RED)



AISWEI New Energy Technology (Jiangsu) Co., Ltd. confirms herewith that the inverters described in this document are in compliance with the fundamental requirements and other relevant provisions of the above mentioned directives.

The entire EU Declaration of Conformity can be found at <http://www.solplanet.net>.







Installation und Inbetriebnahme

# Solarenergie für alle





# Installation und Inbetriebnahme

Solplanet-Wechselrichter mit App



# Installation eines Solplanet- Wechselrichters

1. Installationsvideo ansehen (10 min)
2. Herunterladen der Aiswei-App
3. Einrichtung und Inbetriebnahme über App mit WLAN-Router
  - a. Anlage anlegen und freigeben
  - b. WLAN-Konfiguration
  - c. Netzcode einstellen
  - d. Begrenzung des Leistungsexports **(falls erforderlich)**
4. Einrichtung und Inbetriebnahme über App ohne WLAN-Router
5. Nach Inbetriebnahme
  - a. Lokaler Modus (Einstellungen über WLAN ändern)





10-minütiges  
Installationsvideo  
Einfach zu installieren.

Sehen Sie sich das 10-minütige  
Video über Solplanet auf  
YouTube [hier](#) an:



Einphasige Wechselrichter



Dreiphasige Wechselrichter





# Solplanet-App

Um die App herunterzuladen,  
suchen Sie nach  
„AISWEI“ im App Store  
oder verwenden Sie die unten  
stehenden Links:



# Installation des Wechselrichters und Verbindung mit der App

über das lokale WLAN-  
Netzwerk des Kunden und  
Inbetriebnahme des  
Wechselrichters in der  
AISWEI/Solplanet-Cloud



# 3. Einrichtung und Inbetriebnahme über App mit WLAN-Router



# 3a. Registrierung

Solplanet-Wechselrichter mit App



# Registrierung

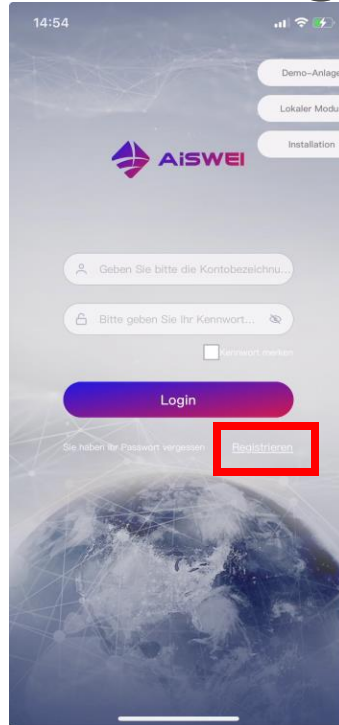

1. Klicken Sie auf **Registrieren**

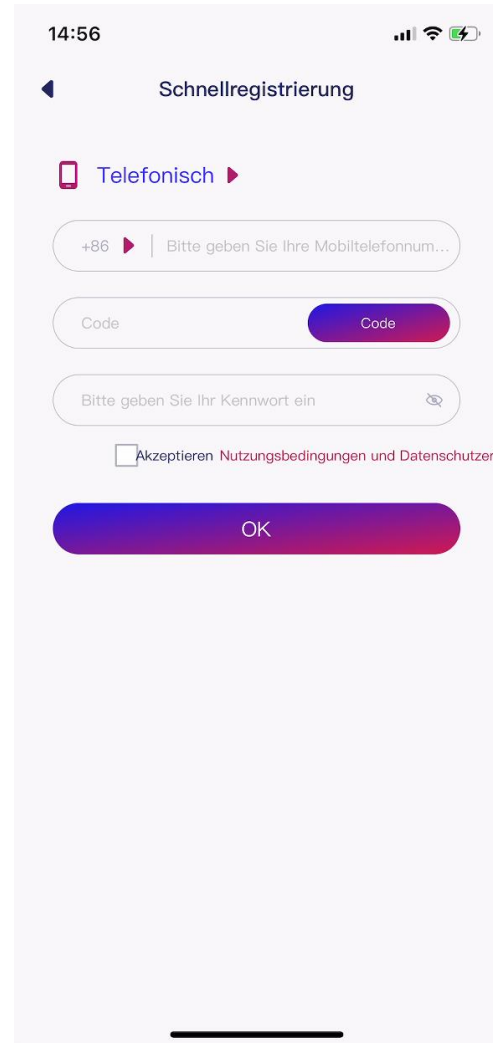

2. **Via Telefonisch** ist systemseitig voreingestellt, kann jedoch auch in via **E-Mail** geändert werden.

2a. Geben Sie Ihre Mobiltelefonnummer ein und wählen Sie die Landesvorwahl.

2b. Klicken Sie auf **Code** und geben Sie den Verifizierungscode ein, wenn Sie ihn per SMS erhalten.

2c. Geben Sie ein Passwort ein.

2d. Akzeptieren Sie die „Nutzungs- und Datenschutzbedingungen“.

2e. Click **OK**



# Registrierung

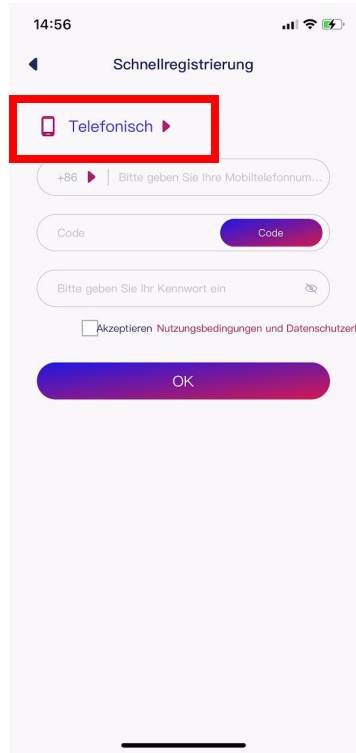

2. Wenn Sie sich per E-Mail anmelden möchten, klicken Sie bitte auf **Telefonisch**

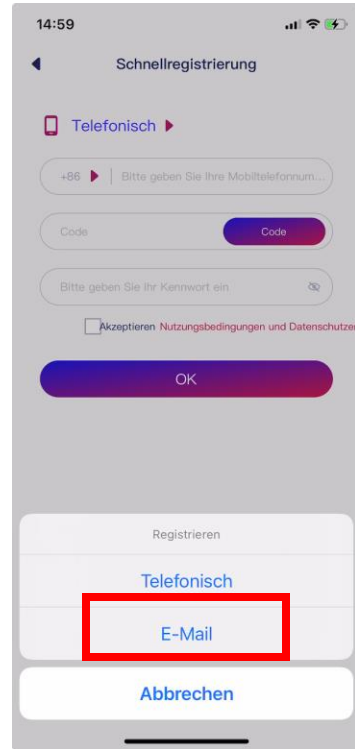

3. Klick auf **Via E-mail**

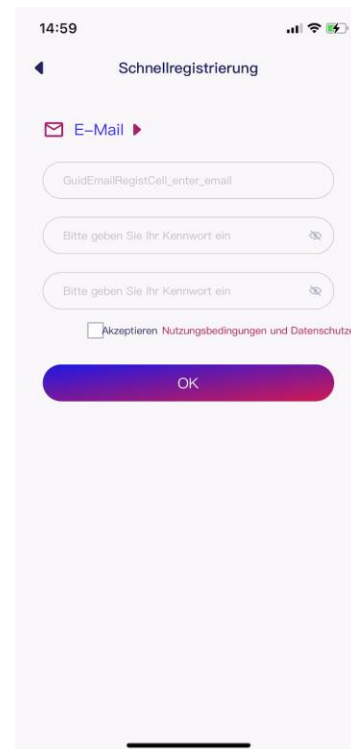

- 4a. Email Adresse eingeben
- 4b. Passwort eingeben
- 4c. das Passwort erneut eingeben zur Bestätigung
- 4d. Klick auf **Nutzungs- und Datenschutzbedingungen**
- 4e. Klick auf **Register**
- 4f. Klick auf den Aktivierungslink, den Sie per E-Mail erhalten haben, um Ihr Konto zu aktivieren.

# 3b. Anlage anlegen

Solplanet-Wechselrichter mit App



# Anlage anlegen

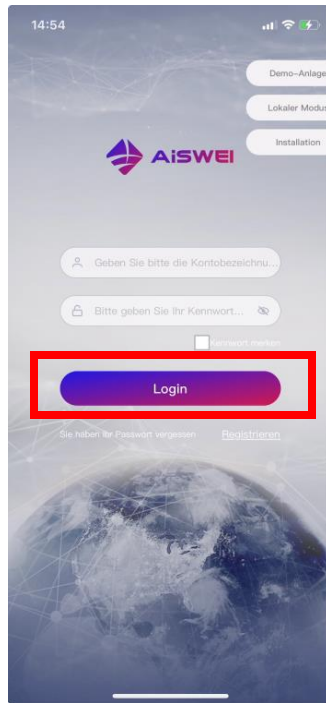

1. Klicken Sie auf **Login**,  
falls Sie über kein Konto  
verfügen, klicken Sie auf  
**Registrieren**

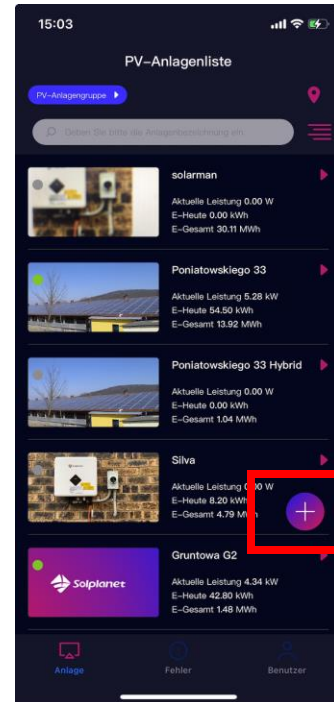

2. Klicken Sie auf **+**

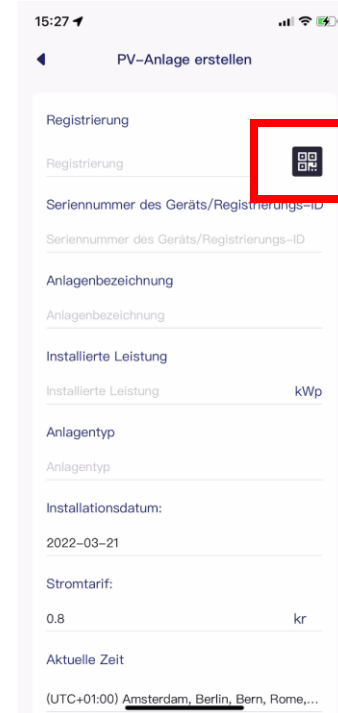

3. Klicken Sie auf 

# Anlage anlegen



4. QR-Code am WLAN-Stick scannen

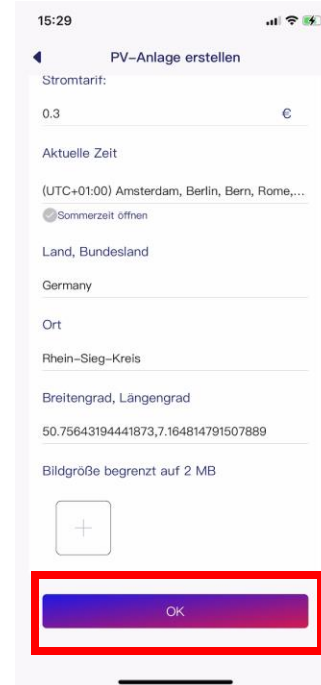

5. Geben Sie weitere Informationen ein und klicken Sie auf **OK**

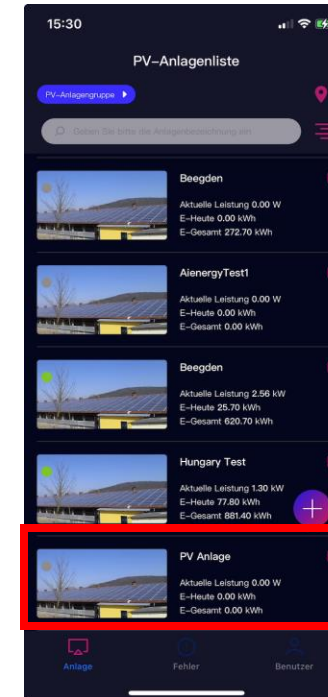

6. Anlage erfolgreich angelegt

# 3c. Anlage freigeben/teilen

Solplanet-Wechselrichter mit App



# Anlage freigeben/teilen

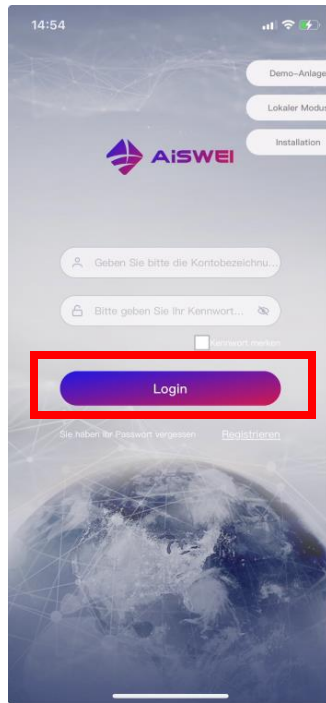

1. Klicken Sie auf **Login**

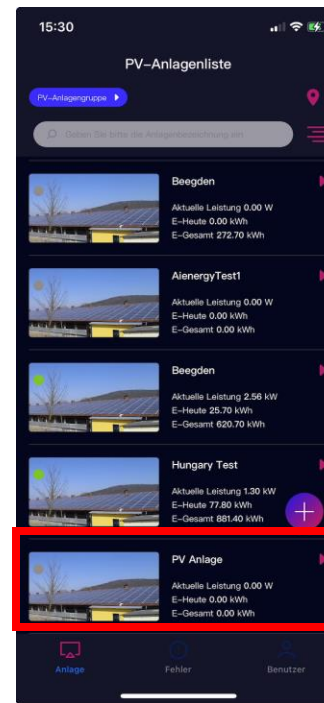

2. Wählen Sie die Anlage aus, die  
freigegeben werden soll

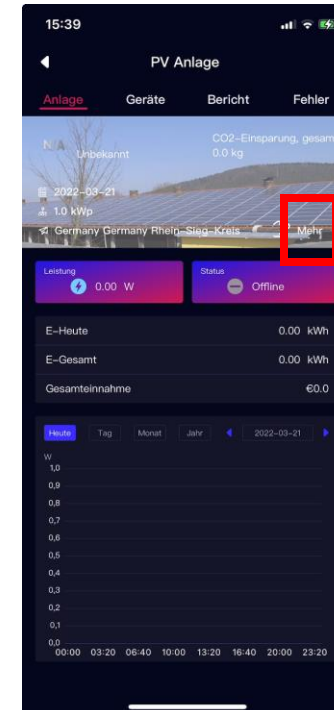

3. Klicken Sie auf **Mehr**

**Hinweis: Die Person, mit der Sie die PV-Anlage teilen möchten, muss sich ebenfalls in der Aiswei-App registrieren.**

# Anlage freigeben/teilen

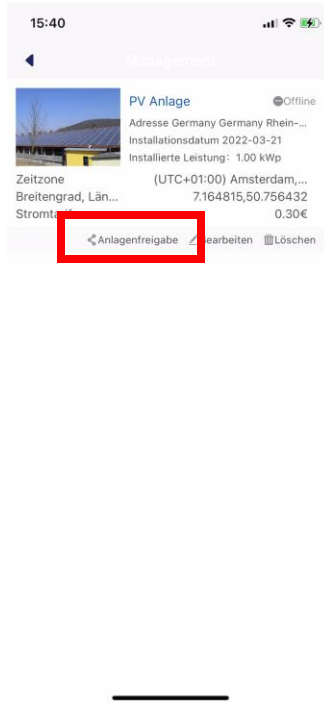

4. Klicken Sie auf **Anlagenfreigabe**

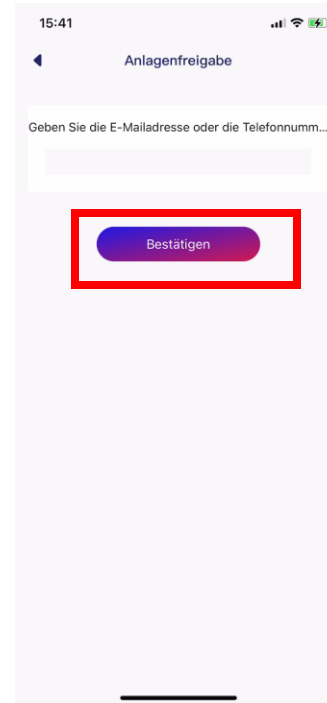

5. Geben Sie das Konto ein, das Sie freigeben möchten und klicken Sie danach auf **Bestätigen**

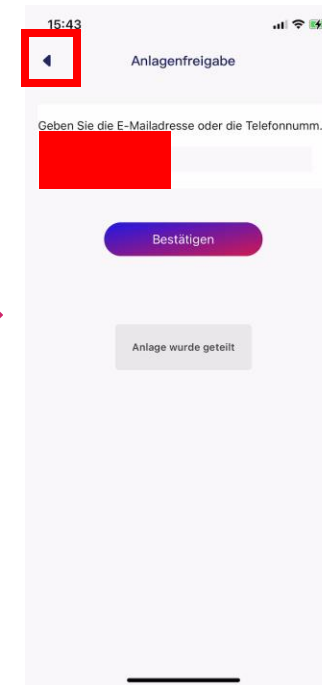

6. Klicken Sie auf ◀

# 3d. WLAN-Konfiguration

Solplanet-Wechselrichter mit App





# WLAN-Konfiguration - Hotspot Netzwerkkonfiguration

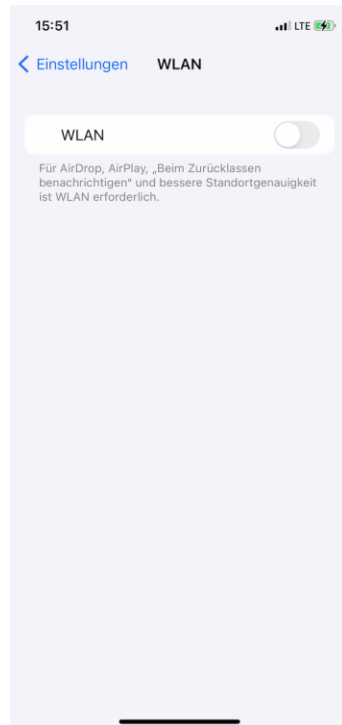

1. WLAN/Wifi-Netzwerk auf dem Endgerät aktivieren



2. Wählen Sie das WLAN-Netzwerk des Kunden aus

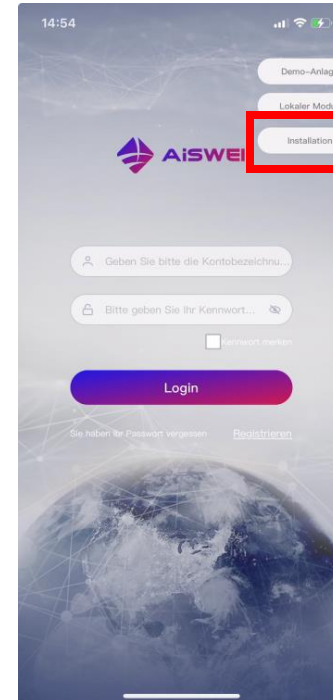

3. Öffnen Sie die Aiswei-App und klicken Sie auf **Installation**

4. Die **grüne LED** am WLAN-Stick sollte dauerhaft leuchten (kann alle 13 Sekunden einmal blinken) und wenn die **blaue LED** aus ist, wählen Sie **Hotspot network configuration** aus

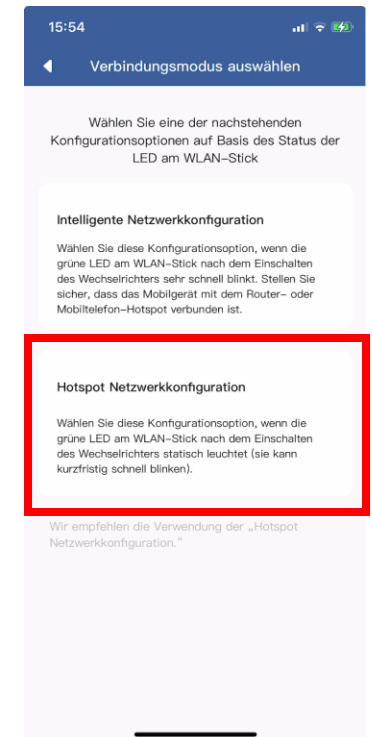

# Hotspot-Netzwerkkonfiguration



5. QR-Code am WLAN-Stick scannen

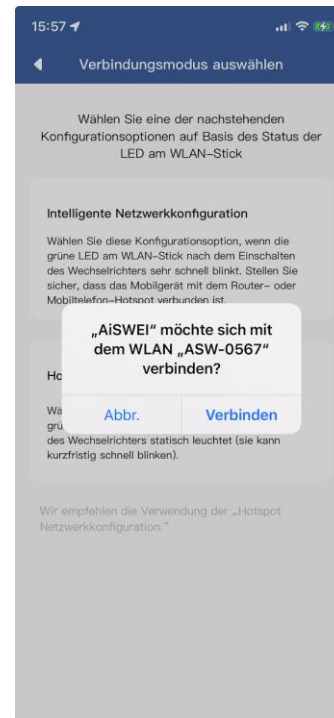

6. Wählen Sie das AISWEI WLAN aus (die letzten 4 Ziffern sind identisch mit der Seriennummer des Sticks)

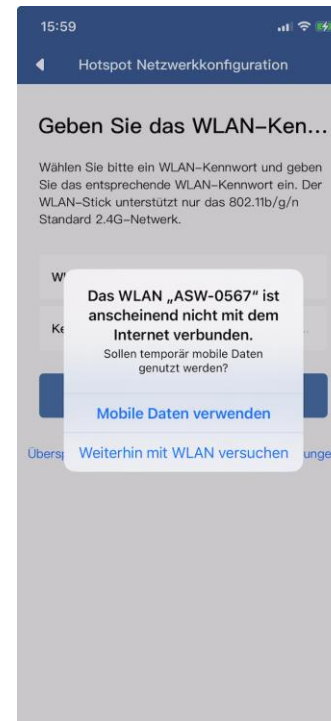

7. Falls Sie diese Meldung erhalten, wählen Sie bitte aus: Weiterhin mit WLAN versuchen

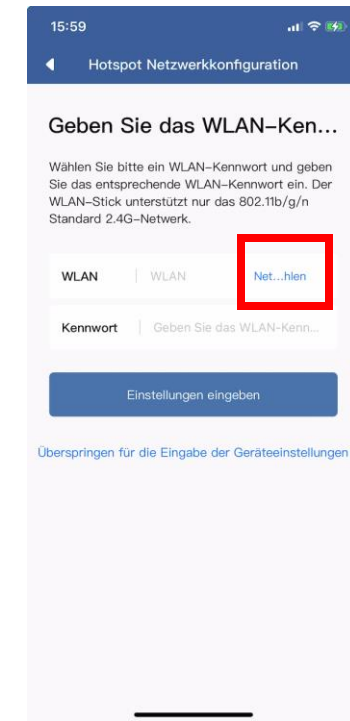
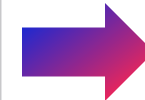

8. Klicken Sie auf **Net...hien**

# Hotspot-Netzwerkkonfiguration

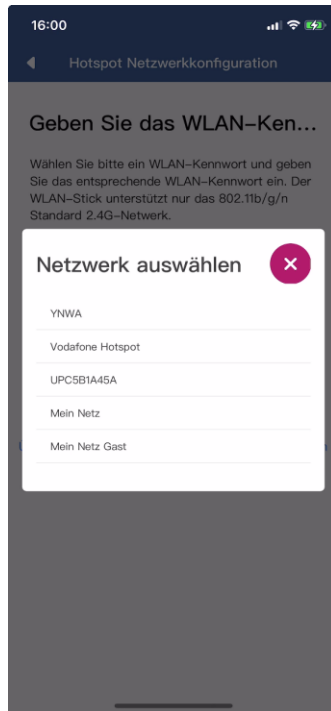

5. Wählen Sie Ihr lokales WLAN aus, geben Sie das Passwort ein und klicken Sie auf OK. Die **blaue LED** am WLAN-Stick sollte anfangen zu blinken.

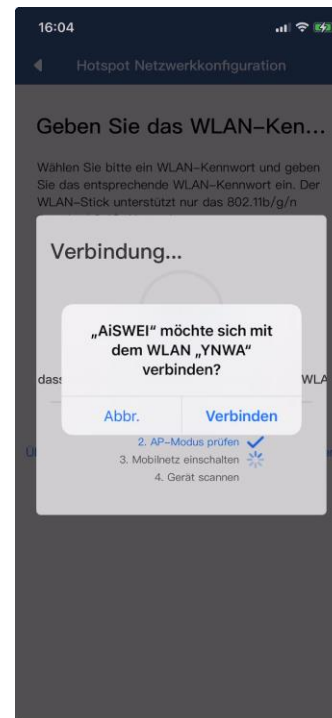

6. Klicken Sie auf **Verbinden**



7. Nach kurzer Zeit sollte die Verbindung zum WLAN-Router erfolgreich sein, Die **blaue LED** am WLAN-Stick sollte dauerhaft leuchten .



8. Nach erfolgreicher WLAN-Konfiguration, klicken Sie auf **Einstellungen eingeben**, Siehe Abschnitt 3e.

# 3e. Netzcode einstellen

Solplanet-Wechselrichter mit App



# Netzcode einstellen



1. Nach erfolgreicher WLAN-Konfiguration, klicken Sie auf **Einstellungen eingeben**

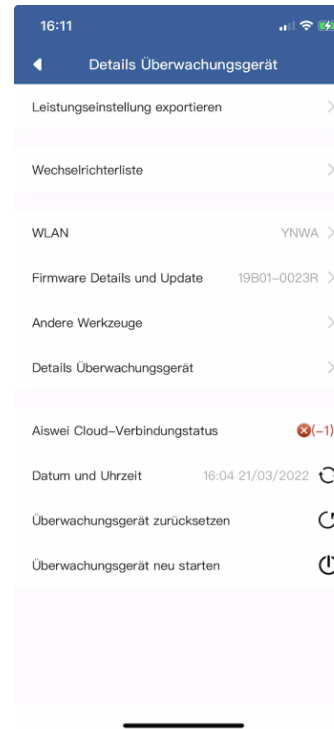

2. Klicken Sie auf **Wechselrichterliste**

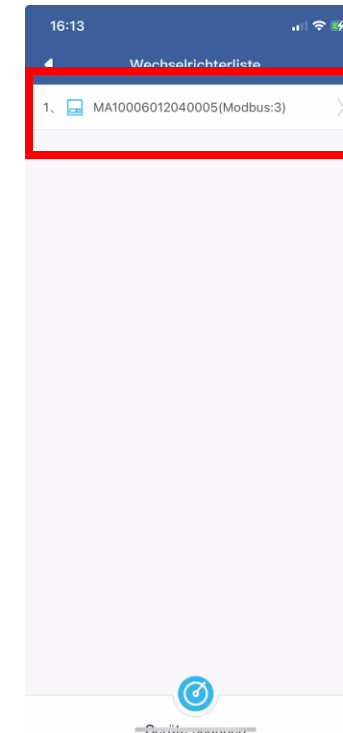

3. Wählen Sie den passenden Wechselrichter aus der Liste  
**Empfehlung: Klicken sie auf Geräte Scannen**

# Netzcode einstellen

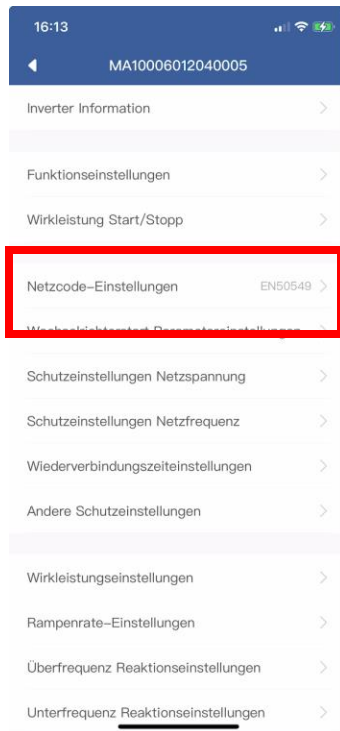

4. Klicken Sie auf  
Netzcode-Einstellungen

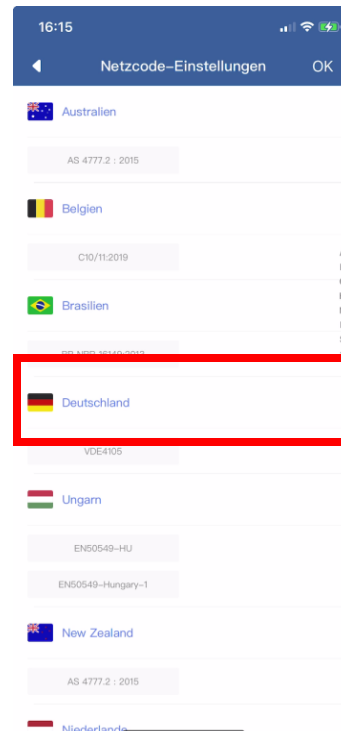

5. Wählen Sie den  
gewünschten Netzcode aus  
und klicken Sie auf OK

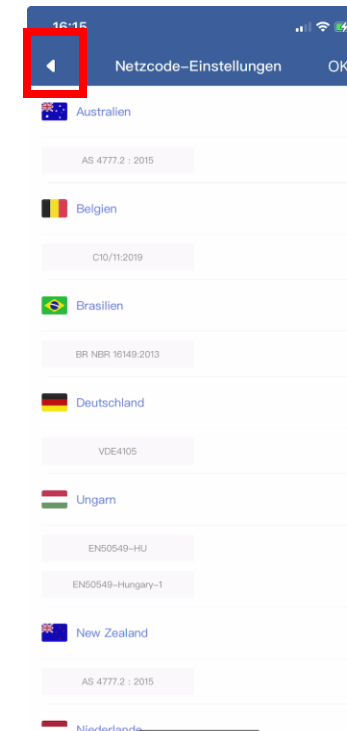

6. Klicken Sie auf ◀

# 3f. Begrenzung des Leistungsexports

Solplanet-Wechselrichter mit App



# Auswahl des Energiezählers

- Die Auswahl des Energiezählers hängt von der Netzversorgung ab
- Eine einphasige Netzversorgung erfordert einen einphasigen Energiezähler - Eastron SDM230
- Eine dreiphasige („Starkstrom“) Netzversorgung erfordert einen dreiphasigen Energiezähler - Eastron SDM630

Netzversorgung	Einphasige Netzversorgung	Dreiphasige Netzversorgung
Einphasiger Wechselrichter	SDM230	SDM630
Dreiphasiger Wechselrichter		SDM630



# Begrenzung des Leistungsexports

- Einphasige Exportgrenzwertkontrolle mit einphasigem Eastron-Energiezähler
- Der Energiezähler muss am „ANSCHLUSSPUNKT“ installiert werden – ***vorzugsweise nach dem Hauptzähler***
- Der Energiezähler misst den „Leistungsimport/export“ **NICHT den „Verbrauch“**

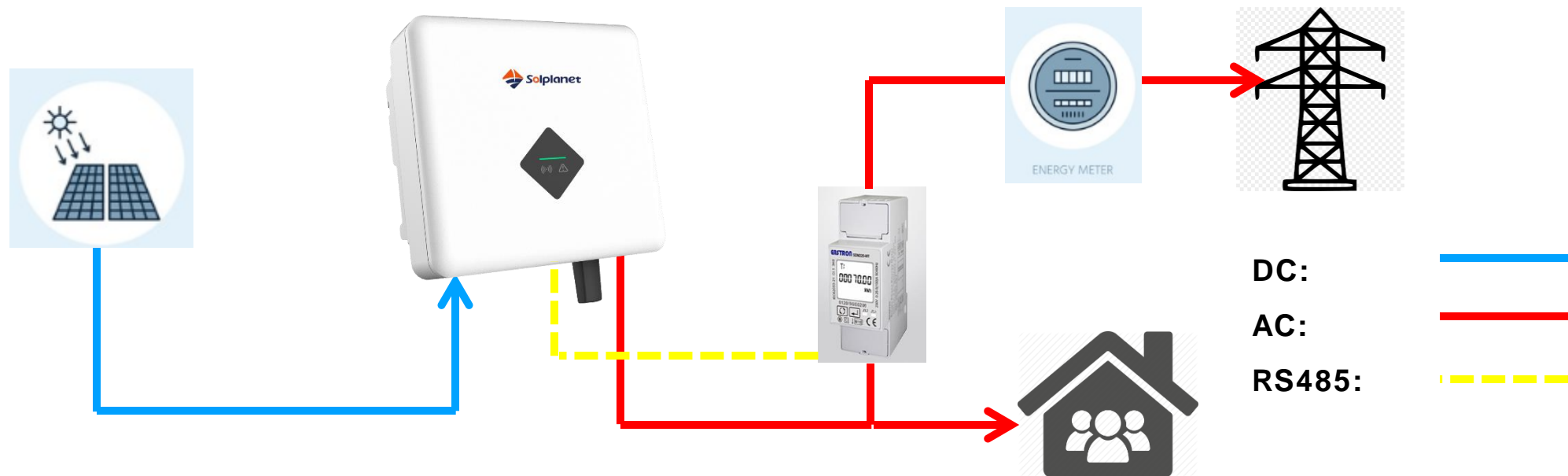

# 1P - Anschlussplan

**L-in/N-in :**

Netzseitig anschließen

**L-out/N-out:**

Lastseitig anschließen

**A/B:**

2-polige Klemme des Wechselrichters

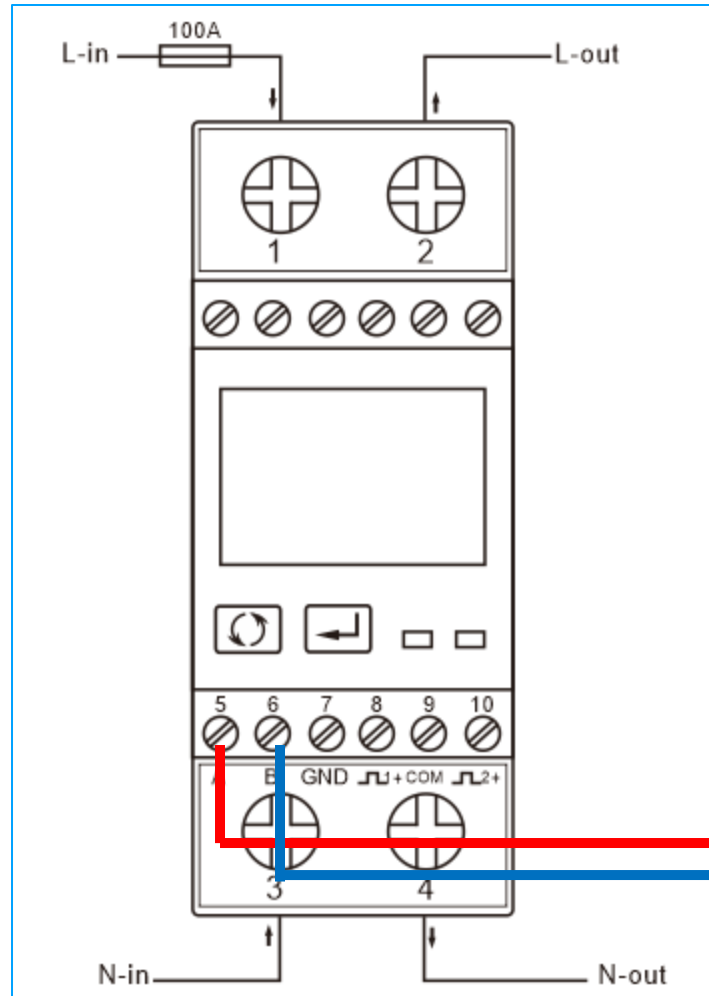

COM1



# 3P - Anschlussplan

## Klemme 1,2,3,4:

Netzseitig anschließen

## Klemme 5,6,7,8:

Lastseitig anschließen

## Kommunikation:

2-polige Klemme des Wechselrichters

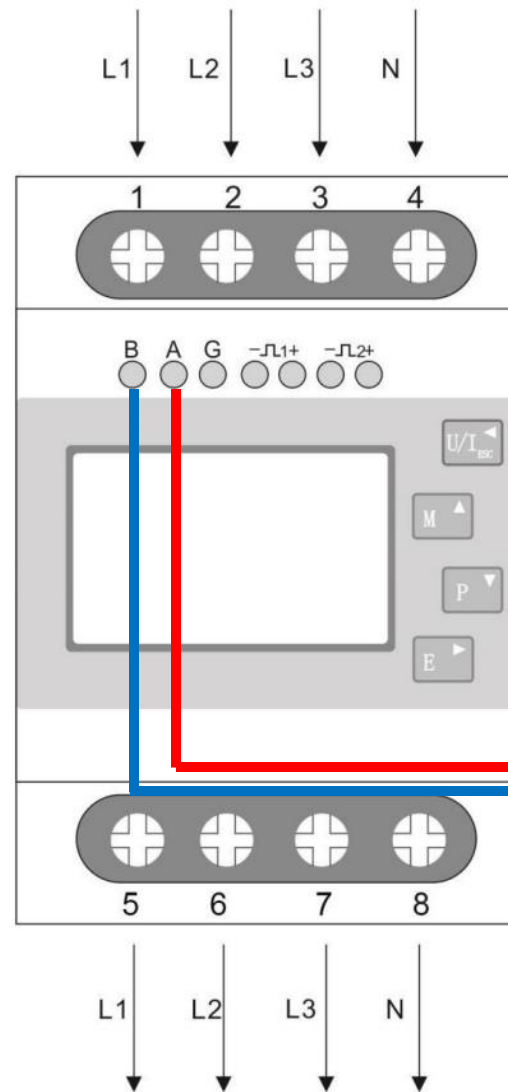

COM1

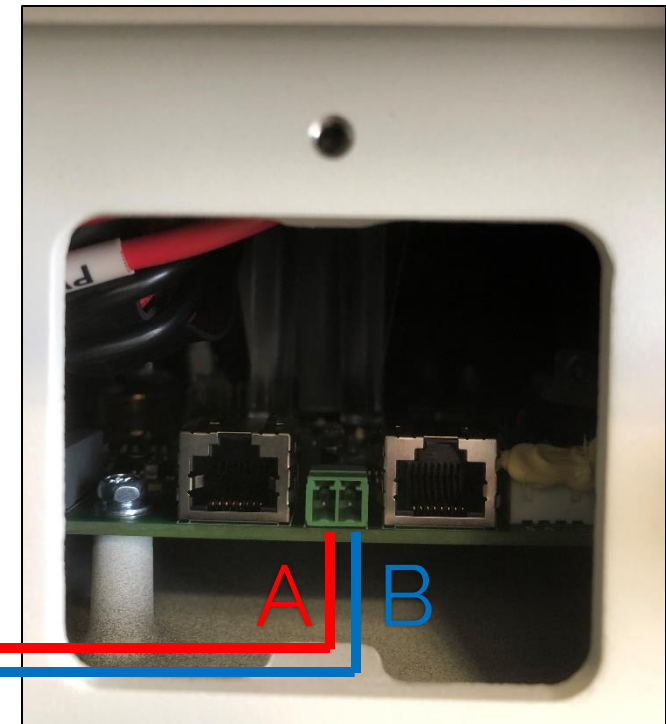

Anwendbare Modelle:

- ASW S-S
- ASW S
- ASW T
- ASW LT
- Eastron SDM630DC

# 3P - Anschlussplan

## Klemme 1,2,3,4:

Netzseitig anschließen

## Klemme 5,6,7,8:

Lastseitig anschließen

## Kommunikation:

2-polige RS485 Klemme

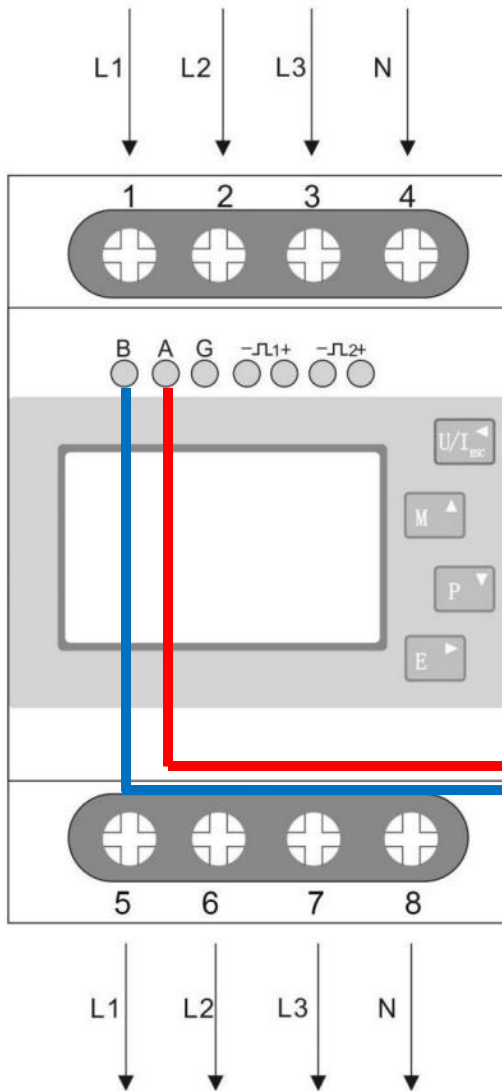

## COM1

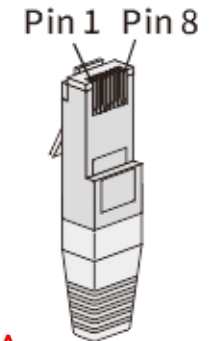
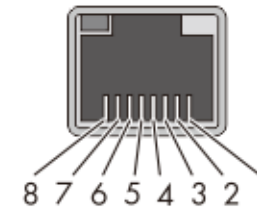

Pin 1=TX\_RS485A  
Pin 2=TX\_RS485B  
Pin 3=NC  
Pin 4=GND  
Pin 5=NC  
Pin 6=NC  
Pin 7=NC  
Pin 8=NC

B A

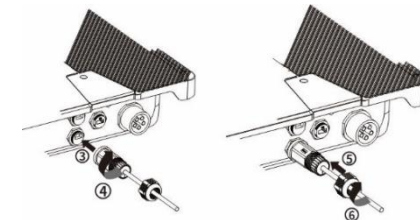

Anwendbare Modelle:

- ASW LT-G2: 8-20 kW
- Eastron SDM630DC

# Dynamische Leistungsbegrenzung

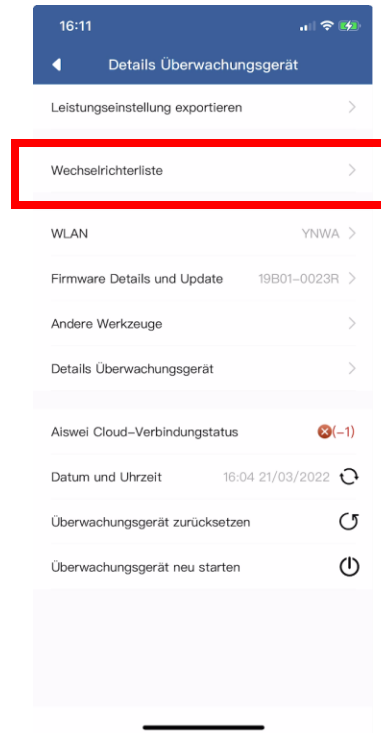

1. Klicken Sie auf **Wechselrichterliste**

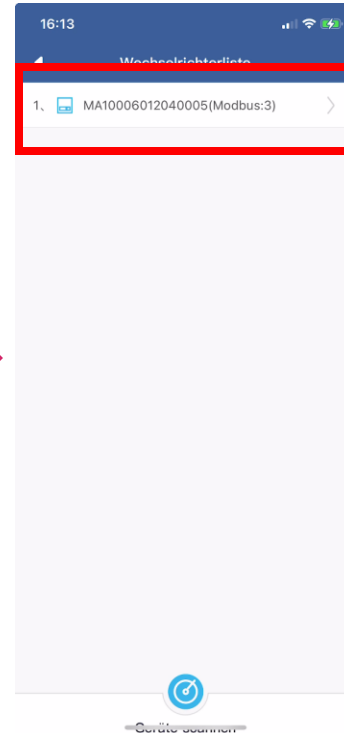

2. Den gewünschten Wechselrichter auswählen

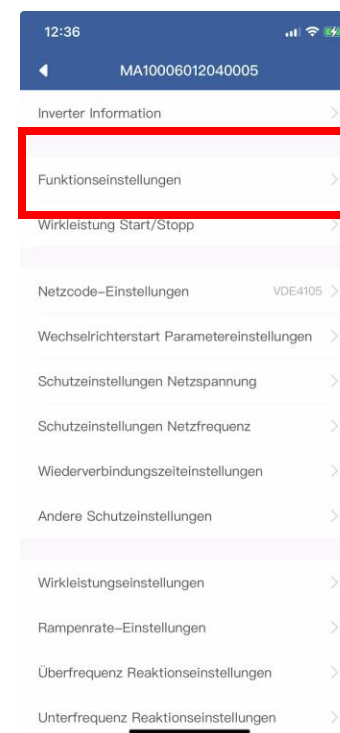

3. Klicken Sie auf **Funktionseinstellungen**

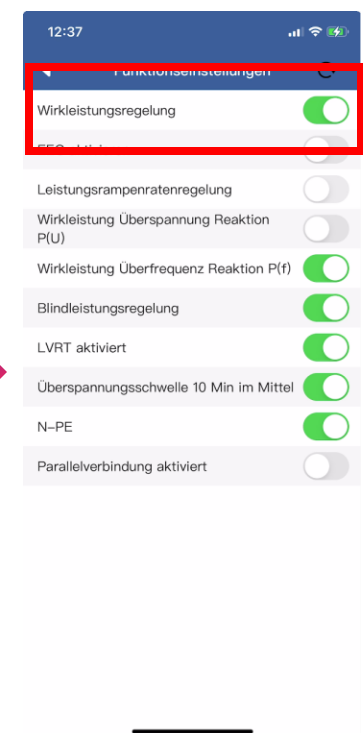

4. Aktivieren Sie **Wirkleistungsregelung**

**Hinweis: reagiert der Wechselrichter nicht auf den schnellen Wechsel der Stromversorgung, führen Sie bitte die folgenden Schritte aus:**

# Dynamische Leistungsbegrenzung

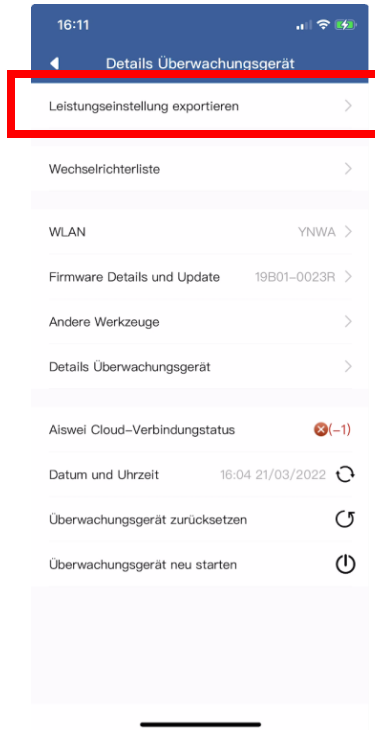

5. Kehren Sie zu Details Überwachungsgerät zurück und klicken Sie auf **Leistungseinstellung exportieren**

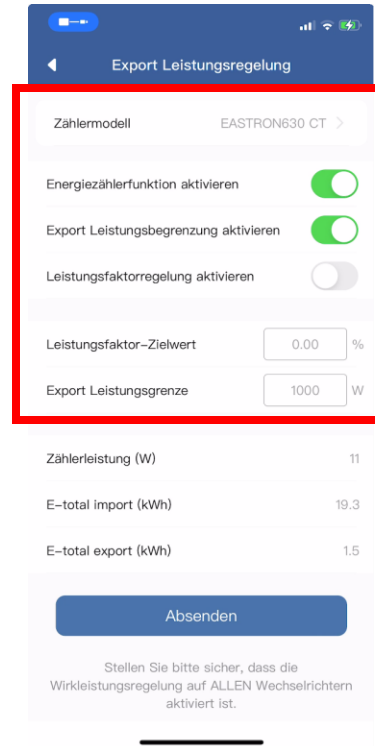

6. Wählen Sie **Zählermodell** aus, aktivieren Sie „**Energiezählerfunktion aktivieren**“ und aktivieren Sie „**Export Leistungsbegrenzung aktivieren**“. Geben Sie **Export Leistungsgrenze** ein, und klicken Sie dann auf **Absenden**

Wenn eine Verbindung zwischen dem Wechselrichter und dem Energiezähler besteht, überprüfen Sie bitte die Einstellungen im Zähler:

**Modbus-Adresse: 001**  
**Baud-Rate: 9600**  
**Parität: keine**  
**Stoppbits 1**

Bitte lesen Sie das Handbuch des Zählers

# Feste Exportgrenze

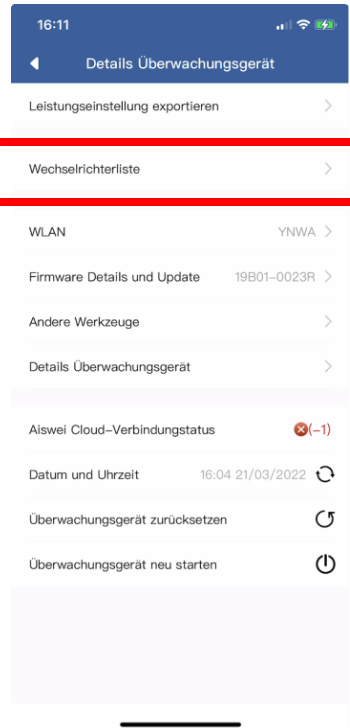

1. Klicken Sie auf **Wechselrichterliste**

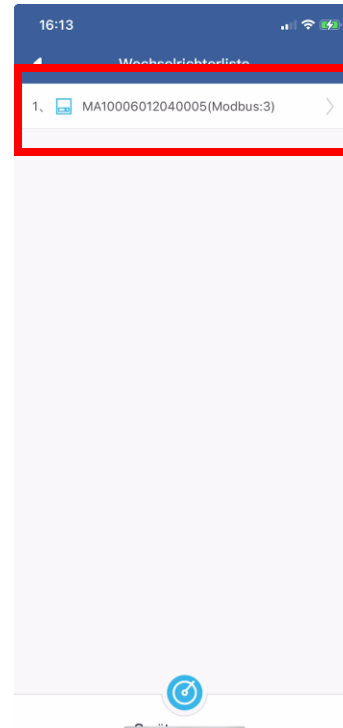

2. Den gewünschten Wechselrichter auswählen

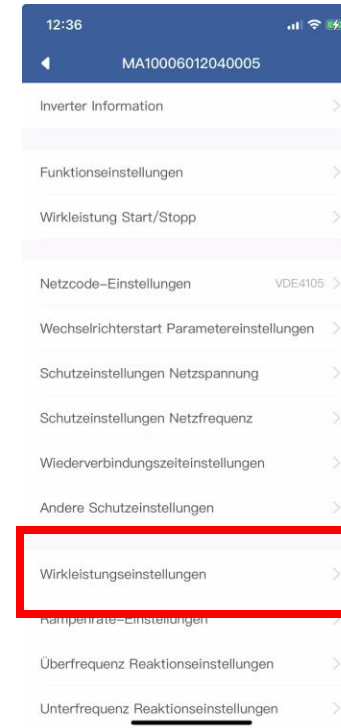

3. Klicken Sie auf

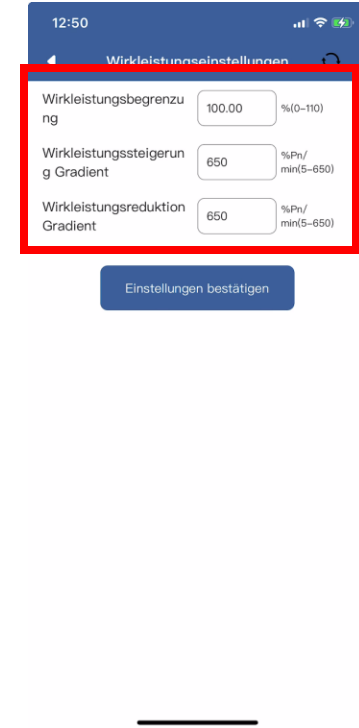

4. Geben Sie **Wirkleistungsbegrenzung** ein, ändern Sie **Wirkleistungssteigerung Gradient** und **Wirkleistungsreduktion Gradient** jeweils auf 650, und klicken Sie dann auf **Einstellungen bestätigen**

# 4. Einrichtung und Inbetriebnahme über App ohne WLAN-Router





# Lokaler Modus

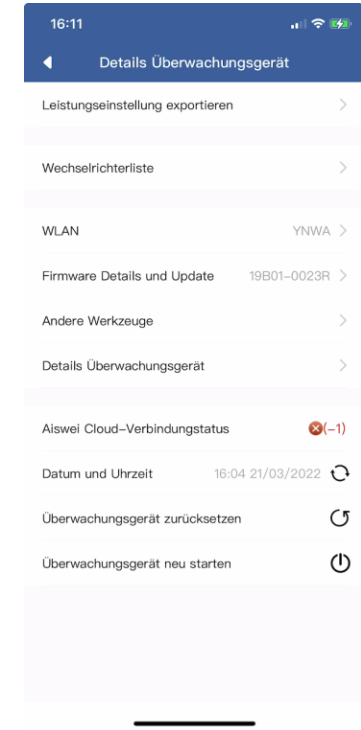
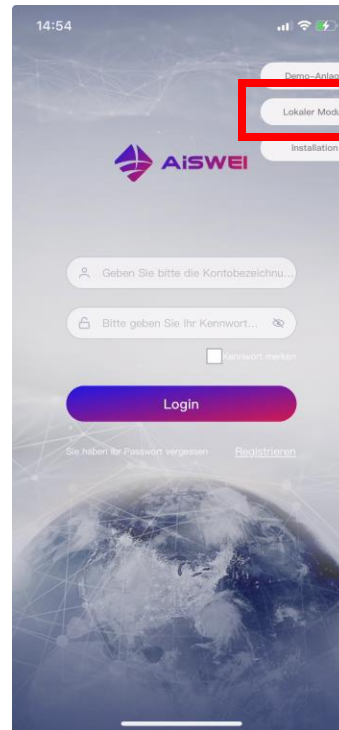

1. Wählen Sie das WLAN des Wechselrichters aus: ASW-XXXX. XXXX sind die letzten 4 Ziffern der Seriennummer des WLAN-Sticks. Das Passwort ist der Registrierungscode, Beides finden Sie auf dem Etikett des WLAN-Sticks.

2. Öffnen Sie die App und wählen Sie **Lokaler Modus** aus

3. Wählen Sie den erforderlichen WLAN-Stick aus. Wenn er nicht angezeigt wird, klicken Sie bitte auf **Geräte Scannen**

4. Netzcode Einstellungen befinden sich in **Wechselrichterliste**

# 5. Nach Inbetriebnahme

Lokaler Modus



# Lokaler Modus



1. Verbinden Sie Ihr Endgerät mit demselben WLAN-Netzwerk, mit dem der WLAN-Stick verbunden ist

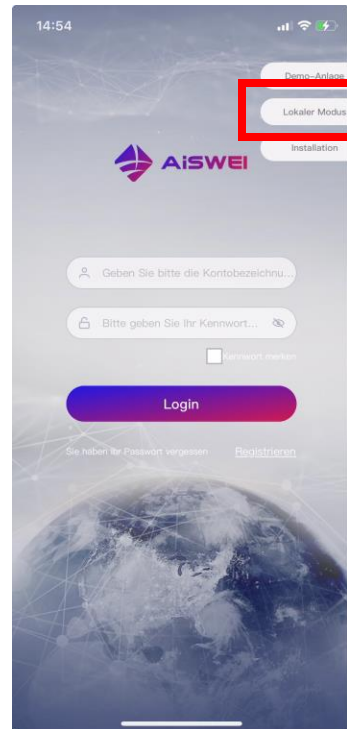

2. Öffnen Sie die App und wählen Sie **Lokaler Modus** aus



3. Wählen Sie den erforderlichen WLAN-Stick aus. Wenn er nicht angezeigt wird, klicken Sie bitte auf **Geräte Scannen**

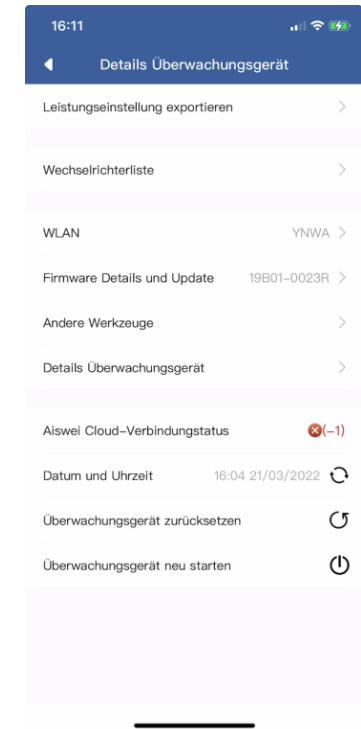

4. Netzcode Einstellungen befinden sich in **Wechselrichterliste**

# 6. Alternative Inbetriebnahme



# Alternative Inbetriebnahme

## Wann sollte ich diese Schritte anwenden?

- Nachdem die PV Anlage angelegt ist (Abschnitt 3b.)
- der WiFi-Stick keine Verbindung zum WLAN-Router mit der **Hotspot-Netzwerkkonfigurationsmethode (Abschnitt 3d.)** herstellen kann
- die **grüne LED** am WLAN-Stick dauerhaft leuchtet (kann alle 13 Sekunden einmal blinken) und die **blaue LED** aus ist



# Lokaler Modus

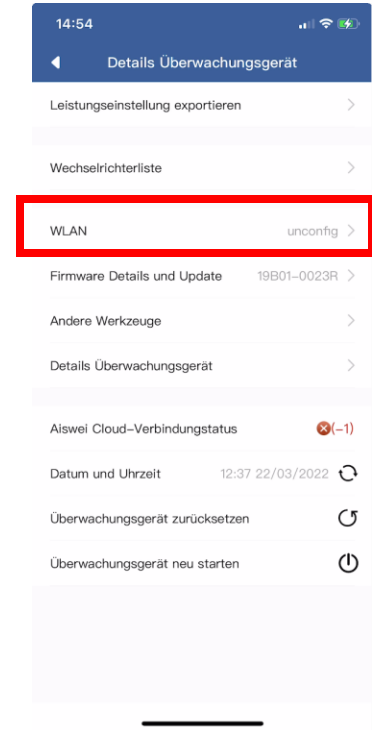
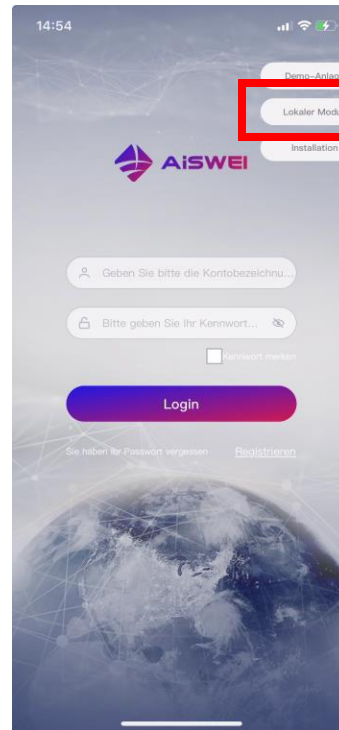

1. Wählen Sie das WLAN des Wechselrichters aus: ASW-XXXX. XXXX sind die letzten 4 Ziffern der Seriennummer des WLAN-Sticks. Das Passwort ist der Registrierungscode, Beides finden Sie auf dem Etikett des WLAN-Sticks.

2. Öffnen Sie die App und wählen Sie **Lokaler Modus** aus

3. Wählen Sie den erforderlichen WLAN-Stick aus. Wenn er nicht angezeigt wird, klicken Sie bitte auf **Geräte Scannen**  
**Empfehlung: Klicken sie auf Geräte Scannen**

4. Wählen Sie **WLAN** aus

# Lokaler Modus

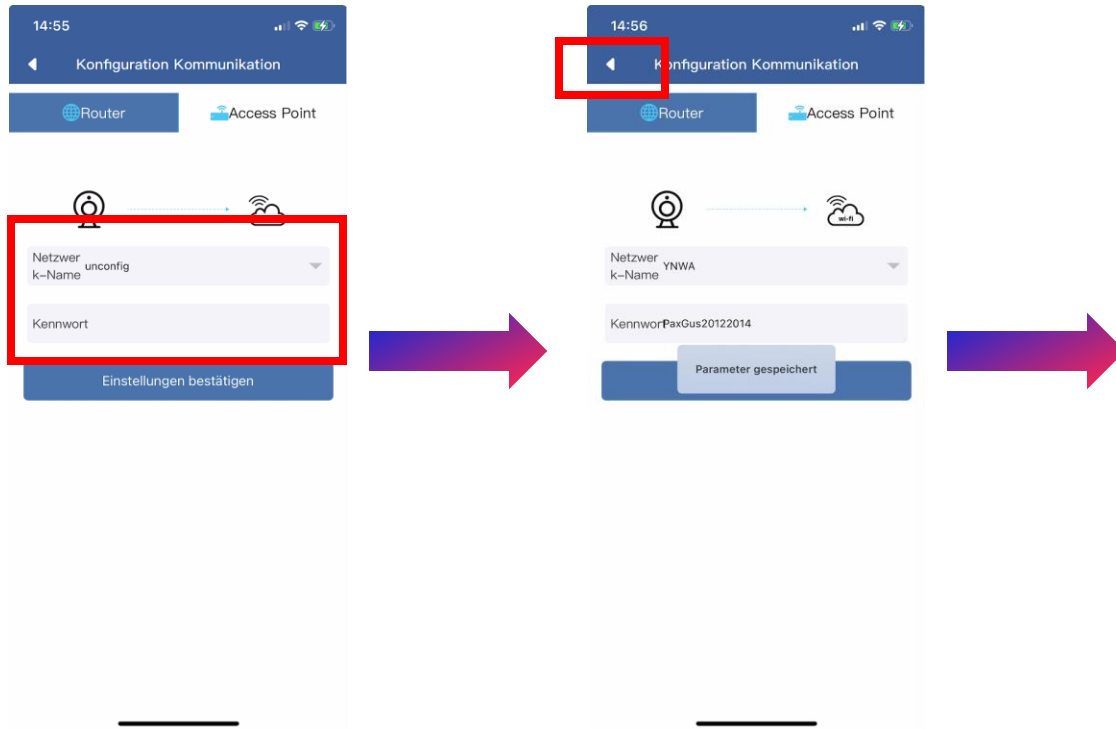

1. Wählen Sie Ihr lokales WLAN aus, geben Sie das Passwort ein und klicken Sie auf OK. Die **blaue LED** am WLAN-Stick sollte anfangen zu blinken.

2. Die **blaue LED** am WLAN-Stick sollte dauerhaft leuchten. Klicken Sie auf ◀ bis Sie den Anmeldebildschirm erreichen.

3. Zur Einrichtung des Netzcodes und der Leistungsbe siehe Abschnitt 5.

5. Nach Inbetriebnahme

Lokaler Modus

# Solarenergie für alle

Service

T. +31 202 402 557 (DE, NL, EN)

E. [service.eu@solplanet.net](mailto:service.eu@solplanet.net)



